

## WIDEBAND, LOW-DISTORTION, FULLY DIFFERENTIAL AMPLIFIERS

### FEATURES

- Fully Differential Architecture
- Bandwidth: 370 MHz
- Slew Rate: 2800 V/ $\mu$ s
- IMD<sub>3</sub>: -90 dBc at 30 MHz
- OIP<sub>3</sub>: 49 dBm at 30 MHz
- Output Common-Mode Control
- Wide Power-Supply Voltage Range: 5 V,  $\pm 5$  V, 12 V, 15 V
- Input Common-Mode Range Shifted to Include Negative Power-Supply Rail
- Power-Down Capability (THS4500)
- Evaluation Module Available

### APPLICATIONS

- High Linearity Analog-to-Digital Converter Preamplifier
- Wireless Communication Receiver Chains
- Single-Ended to Differential Conversion
- Differential Line Driver
- Active Filtering of Differential Signals

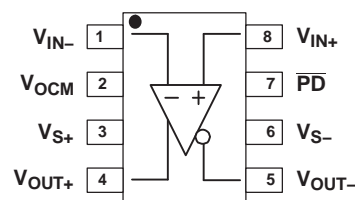

### DESCRIPTION

The THS4500 and THS4501 are high-performance fully differential amplifiers from Texas Instruments. The THS4500, featuring power-down capability, and the THS4501, without power-down capability, set new performance standards for fully differential amplifiers with unsurpassed linearity, supporting 14-bit operation through 40 MHz. Package options include the SOIC-8 and the MSOP-8 with PowerPAD™ for a smaller footprint, enhanced ac performance, and improved thermal dissipation capability.

### RELATED DEVICES

DEVICE <sup>(1)</sup>	DESCRIPTION
THS4500/1	370 MHz, 2800 V/ $\mu$ s, V <sub>ICR</sub> Includes V <sub>S-</sub>
THS4502/3	370 MHz, 2800 V/ $\mu$ s, Centered V <sub>ICR</sub>
THS4120/1	3.3 V, 100 MHz, 43 V/ $\mu$ s, 3.7 nV/ $\sqrt{\text{Hz}}$
THS4130/1	$\pm 15$ V, 150 MHz, 51 V/ $\mu$ s, 1.3 nV/ $\sqrt{\text{Hz}}$
THS4140/1	$\pm 15$ V, 160 MHz, 450 V/ $\mu$ s, 6.5 nV/ $\sqrt{\text{Hz}}$
THS4150/1	$\pm 15$ V, 150 MHz, 650 V/ $\mu$ s, 7.6 nV/ $\sqrt{\text{Hz}}$

(1) Even-numbered devices feature power-down capability.

#### APPLICATION CIRCUIT DIAGRAM

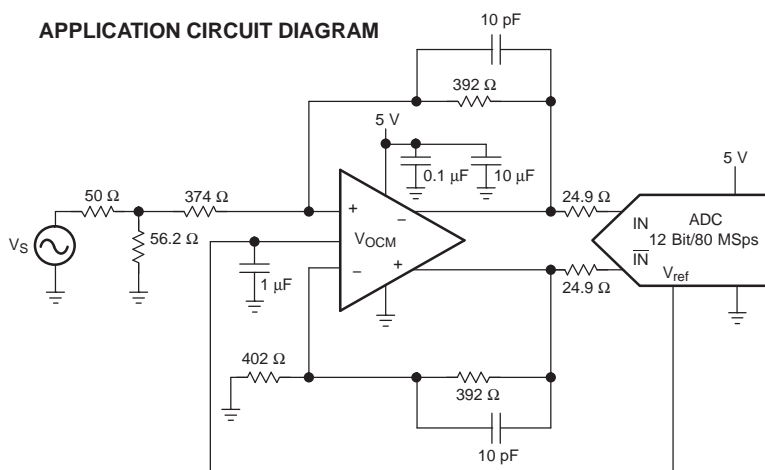

#### THIRD-ORDER INTERMODULATION DISTORTION

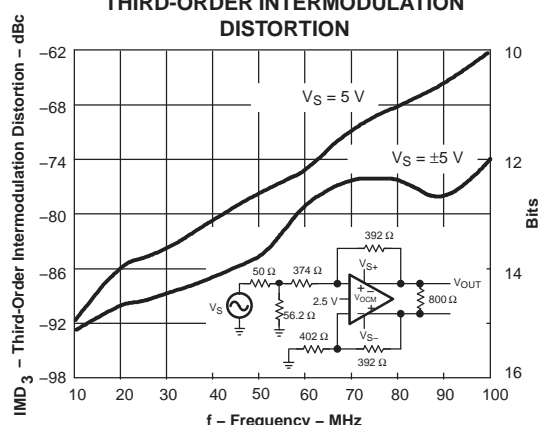

Please be aware that an important notice concerning availability, standard warranty, and use in critical applications of Texas Instruments semiconductor products and disclaimers thereto appears at the end of this data sheet.

PowerPAD is a trademark of Texas Instruments, Incorporated. All other trademarks are the property of their respective owners.



This integrated circuit can be damaged by ESD. Texas Instruments recommends that all integrated circuits be handled with appropriate precautions. Failure to observe proper handling and installation procedures can cause damage.

ESD damage can range from subtle performance degradation to complete device failure. Precision integrated circuits may be more susceptible to damage because very small parametric changes could cause the device not to meet its published specifications.

## ABSOLUTE MAXIMUM RATINGS<sup>(1)</sup>

Over operating free-air temperature range, unless otherwise noted.

		UNIT
Supply voltage, $V_S$		16.5 V
Input voltage, $V_I$		$\pm V_S$
Output current, $I_O$ <sup>(2)</sup>		150 mA
Differential input voltage, $V_{ID}$		4 V
Continuous power dissipation		See <a href="#">Dissipation Rating Table</a>
Maximum junction temperature, $T_J$ <sup>(3)</sup>		+150°C
Maximum junction temperature, continuous operation, long-term reliability, $T_J$		+125°C
Operating free-air temperature range, $T_A$ <sup>(4)</sup>	C suffix	0°C to +70°C
	I suffix	–40°C to +85°C
Storage temperature range, $T_{stg}$		–65°C to +150°C
Lead temperature 1,6 mm (1/16 inch) from case for 10 seconds		+300°C
ESD rating:	HBM	4000 V
	CDM	1000 V
	MM	100 V

- (1) Stresses above these ratings may cause permanent damage. Exposure to absolute maximum conditions for extended periods may degrade device reliability. These are stress ratings only, and functional operation of the device at these or any other conditions beyond those specified is not implied.
- (2) The THS4500/1 may incorporate a PowerPAD on the underside of the chip. This acts as a heat sink and must be connected to a thermally dissipative plane for proper power dissipation. Failure to do so may result in exceeding the maximum junction temperature which could permanently damage the device. See TI technical briefs [SLMA002](#) and [SLMA004](#) for more information about utilizing the PowerPAD thermally-enhanced package.
- (3) The absolute maximum temperature under any condition is limited by the constraints of the silicon process.
- (4) The maximum junction temperature for continuous operation is limited by package constraints. Operation above this temperature may result in reduced reliability and/or lifetime of the device.

## DISSIPATION RATINGS TABLE

PACKAGE	$\theta_{JC}$ (°C/W)	$\theta_{JA}$ <sup>(1)</sup> (°C/W)	POWER RATING <sup>(2)</sup>	
			$T_A \leq +25^\circ\text{C}$	$T_A = +85^\circ\text{C}$
D (8-pin)	38.3	97.5	1.02 W	410 mW
DGN (8-pin)	4.7	58.4	1.71 W	685 mW
DGK (8-pin)	54.2	260	385 mW	154 mW

- (1) This data was taken using the JEDEC standard High-K test PCB.
- (2) Power rating is determined with a junction temperature of +125°C. This is the point where distortion starts to substantially increase. Thermal management of the final PCB should strive to keep the junction temperature at or below +125°C for best performance and long-term reliability.

## RECOMMENDED OPERATING CONDITIONS

		MIN	NOM	MAX	UNIT
Supply voltage	Dual supply		$\pm 5$	$\pm 7.5$	V
	Single supply	4.5	5	15	
Operating free- air temperature, $T_A$	C suffix	0		+70	°C
	I suffix	–40		+85	

**PACKAGE/ORDERING INFORMATION<sup>(1)</sup>**

TEMPERATURE	ORDERABLE PACKAGE AND NUMBER				
	PLASTIC SMALL OUTLINE (D)	PLASTIC MSOP <sup>(2)</sup> PowerPAD		PLASTIC MSOP <sup>(2)</sup>	
		DGN	SYMBOL	DGK	SYMBOL
0°C to +70°C	THS4500CD	THS4500CDGN	BFB	THS4500CDGK	ATVB
	THS4501CD	THS4501CDGN	BFD	THS4501CDGK	ATW
–40°C to +85°C	THS4500ID	THS4500IDGN	BFC	THS4500IDGK	ASV
	THS4501ID	THS4501IDGN	BFE	THS4501IDGK	ASW

- (1) For the most current package and ordering information see the Package Option Addendum at the end of this document, or see the TI web site at [www.ti.com](http://www.ti.com).
- (2) All packages are available taped and reeled. The R suffix standard quantity is 2500. The T suffix standard quantity is 250 (for example, THS4501DT).

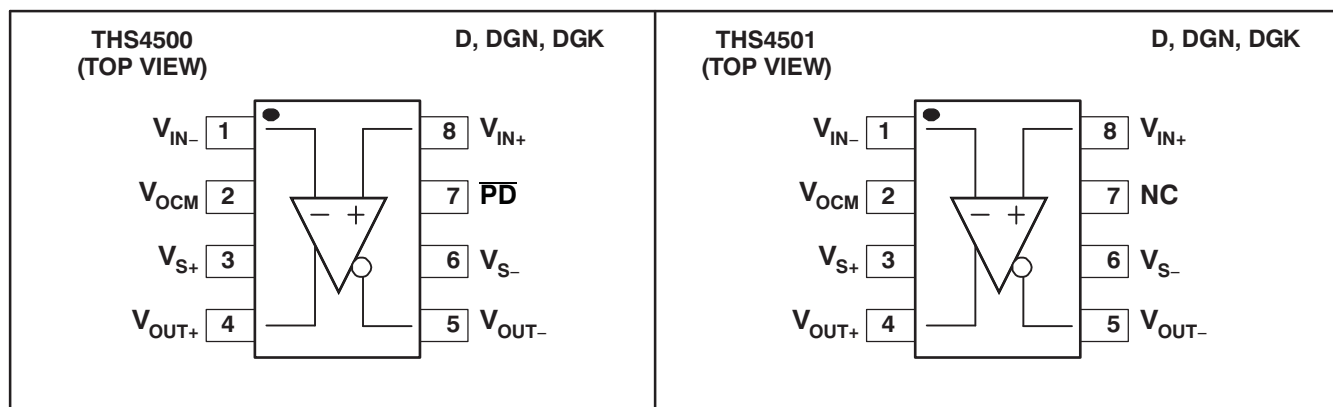
**PIN ASSIGNMENTS**

**ELECTRICAL CHARACTERISTICS:  $V_S = \pm 5\text{ V}$**

$R_F = R_G = 392\ \Omega$ ,  $R_L = 800\ \Omega$ ,  $G = +1$ , and single-ended input, unless otherwise noted.

PARAMETER	TEST CONDITIONS	THS4500 AND THS4501					MIN/ TYP/ MAX
		TYP	OVER TEMPERATURE				
		+25°C	+25°C	0°C to +70°C	-40°C to +85°C	UNITS	
<b>AC PERFORMANCE</b>							
Small-signal bandwidth	$G = +1$ , $P_{IN} = -20\text{ dBm}$ , $R_F = 392\ \Omega$	370				MHz	Typ
	$G = +2$ , $P_{IN} = -30\text{ dBm}$ , $R_F = 1\text{ k}\Omega$	175				MHz	Typ
	$G = +5$ , $P_{IN} = -30\text{ dBm}$ , $R_F = 2.4\text{ k}\Omega$	70				MHz	Typ
	$G = +10$ , $P_{IN} = -30\text{ dBm}$ , $R_F = 5.1\text{ k}\Omega$	30				MHz	Typ
Gain-bandwidth product	$G > +10$	300				MHz	Typ
Bandwidth for 0.1-dB flatness	$P_{IN} = -20\text{ dBm}$	150				MHz	Typ
Large-signal bandwidth	$V_P = 2\text{ V}$	220				MHz	Typ
Slew rate	$4\text{ V}_{PP}$ Step	2800				V/ $\mu\text{s}$	Typ
Rise time	$2\text{ V}_{PP}$ Step	0.4				ns	Typ
Fall time	$2\text{ V}_{PP}$ Step	0.5				ns	Typ
Settling time to 0.01%	$V_O = 4\text{ V}_{PP}$	8.3				ns	Typ
	0.1%	$V_O = 4\text{ V}_{PP}$	6.3			ns	Typ
Harmonic distortion	$G = +1$ , $V_O = 2\text{ V}_{PP}$						Typ
2nd harmonic	$f = 8\text{ MHz}$	-82				dBc	Typ
	$f = 30\text{ MHz}$	-71				dBc	Typ
3rd harmonic	$f = 8\text{ MHz}$	-97				dBc	Typ
	$f = 30\text{ MHz}$	-74				dBc	Typ
Third-order intermodulation distortion	$V_O = 2\text{ V}_{PP}$ , $f_C = 30\text{ MHz}$ , $R_F = 392\ \Omega$ , 200 kHz tone spacing	-90				dBc	Typ
Third-order output intercept point	$f_C = 30\text{ MHz}$ , $R_F = 392\ \Omega$ , Referenced to $50\ \Omega$	49				dBm	Typ
Input voltage noise	$f > 1\text{ MHz}$	7				nV/ $\sqrt{\text{Hz}}$	Typ
Input current noise	$f > 100\text{ kHz}$	1.7				pA/ $\sqrt{\text{Hz}}$	Typ
Overdrive recovery time	Overdrive = 5.5 V	60				ns	Typ
<b>DC PERFORMANCE</b>							
Open-loop voltage gain		55	52	50	50	dB	Min
Input offset voltage		-4	-7/-1	-8/0	-9/+1	mV	Max
Average offset voltage drift				$\pm 10$	$\pm 10$	$\mu\text{V}/^\circ\text{C}$	Typ
Input bias current		4	4.6	5	5.2	$\mu\text{A}$	Max
Average bias current drift				$\pm 10$	$\pm 10$	nA/ $^\circ\text{C}$	Typ
Input offset current		0.5	1	2	2	$\mu\text{A}$	Max
Average offset current drift				$\pm 40$	$\pm 40$	nA/ $^\circ\text{C}$	Typ
<b>INPUT</b>							
Common-mode input range		-5.7/2.6	-5.4/2.3	-5.1/2	-5.1/2	V	Min
Common-mode rejection ratio		80	74	70	70	dB	Min
Input impedance		$10^7 \parallel 1$				$\Omega \parallel \text{pF}$	Typ
<b>OUTPUT</b>							
Differential output voltage swing	$R_L = 1\text{ k}\Omega$	$\pm 8$	$\pm 7.6$	$\pm 7.4$	$\pm 7.4$	V	Min
Differential output current drive	$R_L = 20\ \Omega$	120	110	100	100	mA	Min
Output balance error	$P_{IN} = -20\text{ dBm}$ , $f = 100\text{ kHz}$	-58				dB	Typ
Closed-loop output impedance (single-ended)	$f = 1\text{ MHz}$	0.1				$\Omega$	Typ

**ELECTRICAL CHARACTERISTICS:  $V_S = \pm 5\text{ V}$  (continued)**
 $R_F = R_G = 392\ \Omega$ ,  $R_L = 800\ \Omega$ ,  $G = +1$ , and single-ended input, unless otherwise noted.

PARAMETER	TEST CONDITIONS	THS4500 AND THS4501					MIN/ TYP/ MAX
		TYP	OVER TEMPERATURE				
		+25°C	+25°C	0°C to +70°C	–40°C to +85°C	UNITS	
<b>OUTPUT COMMON-MODE VOLTAGE CONTROL</b>							
Small-signal bandwidth	$R_L = 400\ \Omega$	180				MHz	Typ
Slew rate	2 $V_{PP}$ Step	92				V/ $\mu$ s	Typ
Minimum gain		1	0.98	0.98	0.98	V/V	Min
Maximum gain		1	1.02	1.02	1.02	V/V	Max
Common-mode offset voltage		–0.4	–4.6/+3.8	–6.6/+5.8	–7.6/+6.8	mV	Max
Input bias current	$V_{OCM} = 2.5\text{ V}$	100	150	170	170	$\mu$ A	Max
Input voltage range		$\pm 4$	$\pm 3.7$	$\pm 3.4$	$\pm 3.4$	V	Min
Input impedance		25    1				k $\Omega$    pF	Typ
Maximum default voltage	$V_{OCM}$ left floating	0	0.05	0.10	0.10	V	Max
Minimum default voltage	$V_{OCM}$ left floating	0	–0.05	–0.10	–0.10	V	Min
<b>POWER SUPPLY</b>							
Specified operating voltage		$\pm 5$	7.5	7.5	7.5	V	Max
Maximum quiescent current		23	28	32	34	mA	Max
Minimum quiescent current		23	18	14	12	mA	Min
Power-supply rejection ( $\pm$ PSRR)		80	76	73	70	dB	Min
<b>POWER-DOWN (THS4500 ONLY)</b>							
Enable voltage threshold	Device enabled <i>ON</i> above –2.9 V		–2.9			V	Min
Disable voltage threshold	Device disabled <i>OFF</i> below –4.3 V		–4.3			V	Max
Power-down quiescent current		800	1000	1200	1200	$\mu$ A	Max
Input bias current		200	240	260	260	$\mu$ A	Max
Input impedance		50    1				k $\Omega$    pF	Typ
Turn-on time delay		1000				ns	Typ
Turn-off time delay		800				ns	Typ

**ELECTRICAL CHARACTERISTICS:  $V_S = 5\text{ V}$**

$R_F = R_G = 392\ \Omega$ ,  $R_L = 800\ \Omega$ ,  $G = +1$ , and single-ended input, unless otherwise noted.

PARAMETER	TEST CONDITIONS	THS4500 AND THS4501					
		TYP	OVER TEMPERATURE				MIN/ YP/M AX
		+25°C	+25°C	0°C to +70°C	–40°C to +85°C	UNITS	
<b>AC PERFORMANCE</b>							
Small-signal bandwidth	$G = +1$ , $P_{IN} = -20\text{ dBm}$ , $R_F = 392\ \Omega$	320				MHz	Typ
	$G = +2$ , $P_{IN} = -30\text{ dBm}$ , $R_F = 1\text{ k}\Omega$	160				MHz	Typ
	$G = +5$ , $P_{IN} = -30\text{ dBm}$ , $R_F = 2.4\text{ k}\Omega$	60				MHz	Typ
	$G = +10$ , $P_{IN} = -30\text{ dBm}$ , $R_F = 5.1\text{ k}\Omega$	30				MHz	Typ
Gain-bandwidth product	$G > +10$	300				MHz	Typ
Bandwidth for 0.1-dB flatness	$P_{IN} = -20\text{ dBm}$	180				MHz	Typ
Large-signal bandwidth	$V_P = 1\text{ V}$	200				MHz	Typ
Slew rate	$2\ V_{PP}$ Step	1300				V/ $\mu$ s	Typ
Rise time	$2\ V_{PP}$ Step	0.5				ns	Typ
Fall time	$2\ V_{PP}$ Step	0.6				ns	Typ
Settling time to 0.01%	$V_O = 2\text{ V}$ Step	13.1				ns	Typ
	$V_O = 2\text{ V}$ Step	8.3				ns	Typ
Harmonic distortion	$G = +1$ , $V_O = 2\ V_{PP}$						Typ
2nd harmonic	$f = 8\text{ MHz}$ ,	–80				dBc	Typ
	$f = 30\text{ MHz}$	–55				dBc	Typ
3rd harmonic	$f = 8\text{ MHz}$	–76				dBc	Typ
	$f = 30\text{ MHz}$	–60				dBc	Typ
Input voltage noise	$f > 1\text{ MHz}$	7				nV/ $\sqrt{\text{Hz}}$	Typ
Input current noise	$f > 100\text{ kHz}$	1.7				pA/ $\sqrt{\text{Hz}}$	Typ
Overdrive recovery time	Overdrive = 5.5 V	60				ns	Typ
<b>DC PERFORMANCE</b>							
Open-loop voltage gain		54	51	49	49	dB	Min
Input offset voltage		–4	–7/–1	–8/0	–9/+1	mV	Max
Average offset voltage drift				$\pm 10$	$\pm 10$	$\mu\text{V}/^\circ\text{C}$	Typ
Input bias current		4	4.6	5	5.2	$\mu\text{A}$	Max
Average bias current drift				$\pm 10$	$\pm 10$	nA/ $^\circ\text{C}$	Typ
Input offset current		0.5	0.7	1.2	1.2	$\mu\text{A}$	Max
Average offset current drift				$\pm 20$	$\pm 20$	nA/ $^\circ\text{C}$	Typ
<b>INPUT</b>							
Common-mode input range		–0.7/2.6	–0.4/2.3	–0.1/2	–0.1/2	V	Min
Common-mode rejection ratio		80	74	70	70	dB	Min
Input Impedance		$10^7 \parallel 1$				$\Omega \parallel \text{pF}$	Typ
<b>OUTPUT</b>							
Differential output voltage swing	$R_L = 1\text{ k}\Omega$ , Referenced to 2.5 V	$\pm 3.3$	$\pm 3$	$\pm 2.8$	$\pm 2.8$	V	Min
Output current drive	$R_L = 20\ \Omega$	100	90	80	80	mA	Min
Output balance error	$P_{IN} = -20\text{ dBm}$ , $f = 100\text{ kHz}$	–58				dB	Typ
Closed-loop output impedance (single-ended)	$f = 1\text{ MHz}$	0.1				$\Omega$	Typ

**ELECTRICAL CHARACTERISTICS:  $V_S = 5\text{ V}$  (continued)**
 $R_F = R_G = 392\ \Omega$ ,  $R_L = 800\ \Omega$ ,  $G = +1$ , and single-ended input, unless otherwise noted.

PARAMETER	TEST CONDITIONS	THS4500 AND THS4501					
		TYP	OVER TEMPERATURE				MIN/ YP/M AX
		+25°C	+25°C	0°C to +70°C	–40°C to +85°C	UNITS	
<b>OUTPUT COMMON-MODE VOLTAGE CONTROL</b>							
Small-signal bandwidth	$R_L = 400\ \Omega$	180				MHz	Typ
Slew rate	$2\ V_{PP}$ Step	80				V/ $\mu$ s	Typ
Minimum gain		1	0.98	0.98	0.98	V/V	Min
Maximum gain		1	1.02	1.02	1.02	V/V	Max
Common-mode offset voltage		0.4	–2.6/3.4	–4.2/5.4	–5.6/6.4	mV	Max
Input bias current	$V_{OCM} = 2.5\text{ V}$	1	2	3	3	$\mu$ A	Max
Input voltage range		1/4	1.2/3.8	1.3/3.7	1.3/3.7	V	Min
Input impedance		25    1				k $\Omega$    pF	Typ
Maximum default voltage	$V_{OCM}$ left floating	2.5	2.55	2.6	2.6	V	Max
Minimum default voltage	$V_{OCM}$ left floating	2.5	2.45	2.4	2.4	V	Min
<b>POWER SUPPLY</b>							
Specified operating voltage		5	15	15	15	V	Max
Maximum quiescent current		20	25	29	31	mA	Max
Minimum quiescent current		20	16	12	10	mA	Min
Power-supply rejection (+PSRR)		75	72	69	66	dB	Min
<b>POWER -DOWN (THS4500 ONLY)</b>							
Enable voltage threshold	Device enabled <i>ON</i> above 2.1 V		2.1			V	Min
Disable voltage threshold	Device disabled <i>OFF</i> below 0.7 V		0.7			V	Max
Power-down quiescent current		600	800	1200	1200	$\mu$ A	Max
Input bias current		100	125	140	140	$\mu$ A	Max
Input impedance		50    1				k $\Omega$    pF	Typ
Turn-on time delay		1000				ns	Typ
Turn-off time delay		800				ns	Typ

## TYPICAL CHARACTERISTICS

**Table of Graphs ( $\pm 5$  V)**

		FIGURE
Small-signal unity-gain frequency response		1
Small-signal frequency response		2
0.1-dB gain flatness frequency response		3
Large-signal frequency response		4
Harmonic distortion (single-ended input to differential output)	vs Frequency	5, 7, 13, 15
Harmonic distortion (differential input to differential output)	vs Frequency	6, 8, 14, 16
Harmonic distortion (single-ended input to differential output)	vs Output voltage swing	9, 11, 17, 19
Harmonic distortion (differential input to differential output)	vs Output voltage swing	10, 12, 18, 20
Harmonic distortion (single-ended input to differential output)	vs Load resistance	21
Harmonic distortion (differential input to differential output)	vs Load resistance	22
Third-order intermodulation distortion (single-ended input to differential output)	vs Frequency	23
Third-order output intercept point	vs Frequency	24
Slew rate	vs Differential output voltage step	25
Settling time		26, 27
Large-signal transient response		28
Small-signal transient response		29
Overdrive recovery		30, 31
Voltage and current noise	vs Frequency	32
Rejection ratios	vs Frequency	33
Rejection ratios	vs Case temperature	34
Output balance error	vs Frequency	35
Open-loop gain and phase	vs Frequency	36
Open-loop gain	vs Case temperature	37
Input bias offset current	vs Case temperature	38
Quiescent current	vs Supply voltage	39
Input offset voltage	vs Case temperature	40
Common-mode rejection ratio	vs Input common-mode range	41
Output drive	vs Case temperature	42
Harmonic distortion (single-ended and differential input to differential output)	vs Output common-mode voltage	43
Small-signal frequency response at $V_{OCM}$		44
Output offset voltage at $V_{OCM}$	vs Output common-mode voltage	45
Quiescent current	vs Power-down voltage	46
Turn-on and turn-off delay times		47
Single-ended output impedance in power-down	vs Frequency	48
Power-down quiescent current	vs Case temperature	49
	vs Supply voltage	50



**Table of Graphs (5 V)**

		<b>FIGURE</b>
Small-signal unity-gain frequency response		51
Small-signal frequency response		52
0.1-dB gain flatness frequency response		53
Large-signal frequency response		54
Harmonic distortion (single-ended input to differential output)	vs Frequency	55, 57, 63, 65
Harmonic distortion (differential input to differential output)	vs Frequency	56, 58, 64, 66
Harmonic distortion (single-ended input to differential output)	vs Output voltage swing	59, 61, 67, 69
Harmonic distortion (differential input to differential output)	vs Output voltage swing	60, 62, 68, 70
Harmonic distortion (single-ended input to differential output)	vs Load resistance	71
Harmonic distortion (differential input to differential output)	vs Load resistance	72
Third-order intermodulation distortion	vs Frequency	73
Third-order intercept point	vs Frequency	74
Slew rate	vs Differential output voltage step	75
Large-signal transient response		76
Small-signal transient response		77
Voltage and current noise	vs Frequency	78
Rejection ratios	vs Frequency	79
Rejection ratios	vs Case temperature	80
Output balance error	vs Frequency	81
Open-loop gain and phase	vs Frequency	82
Open-loop gain	vs Case temperature	83
Input bias offset current	vs Case temperature	84
Quiescent current	vs Supply voltage	85
Input offset voltage	vs Case temperature	86
Common-mode rejection ratio	vs Input common-mode range	87
Output drive	vs Case temperature	88
Harmonic distortion (single-ended and differential input)	vs Output common-mode voltage	89
Small-signal frequency response at $V_{OCM}$		90
Output offset voltage	vs Output common-mode voltage	91
Quiescent current	vs Power-down voltage	92
Turn-on and turn-off delay times		93
Single-ended output impedance in power-down	vs Frequency	94
Power-down quiescent current	vs Case temperature	95
	vs Supply voltage	96

**TYPICAL CHARACTERISTICS: ±5 V**

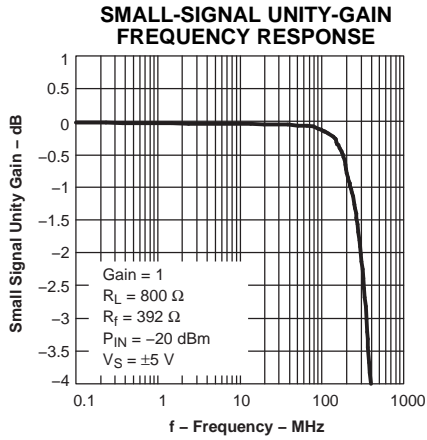

Figure 1.

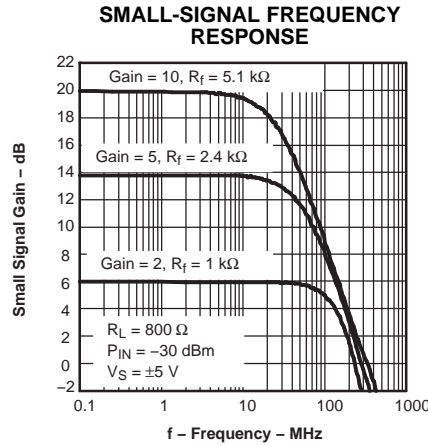

Figure 2.

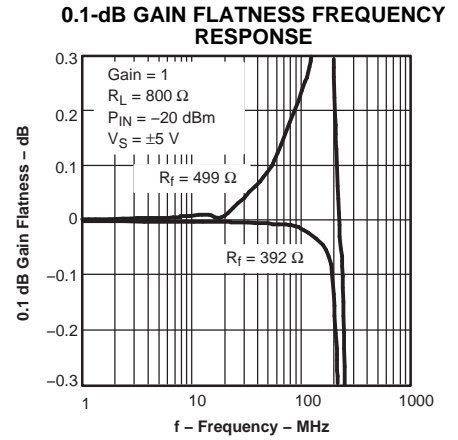

Figure 3.

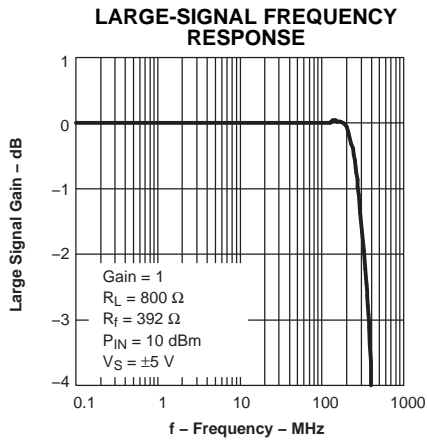

Figure 4.

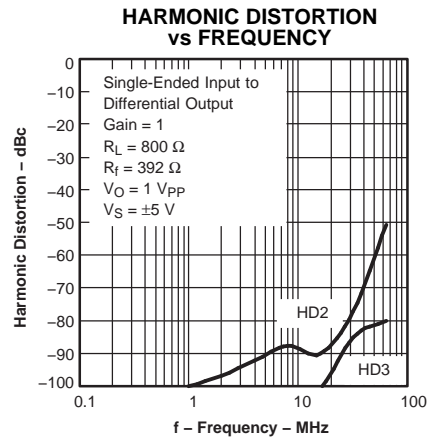

Figure 5.

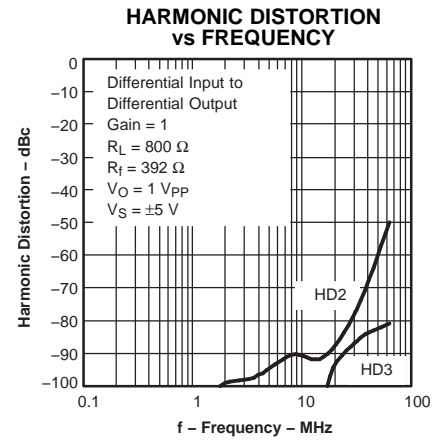

Figure 6.

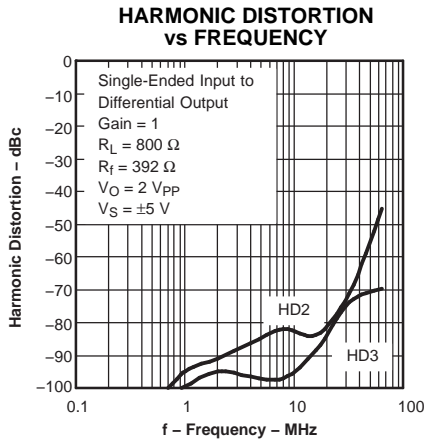

Figure 7.

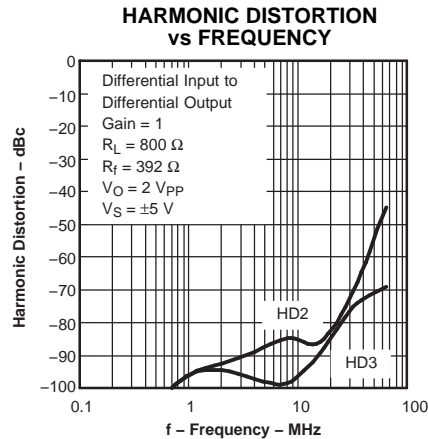

Figure 8.

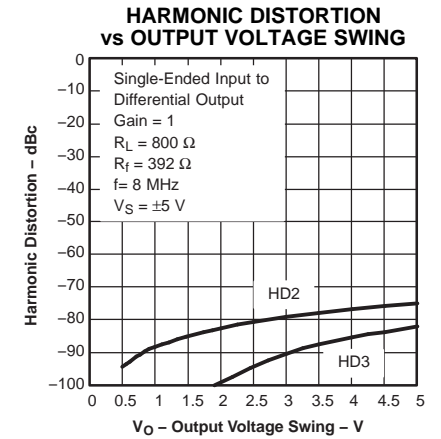

Figure 9.

TYPICAL CHARACTERISTICS: ±5 V (continued)

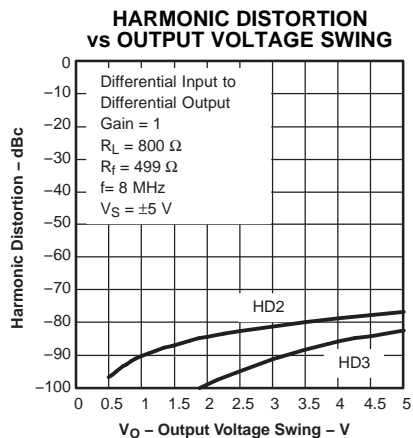

Figure 10.

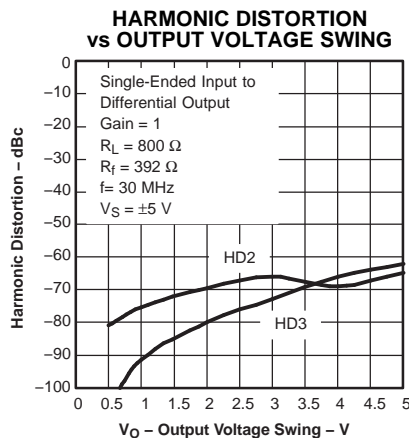

Figure 11.

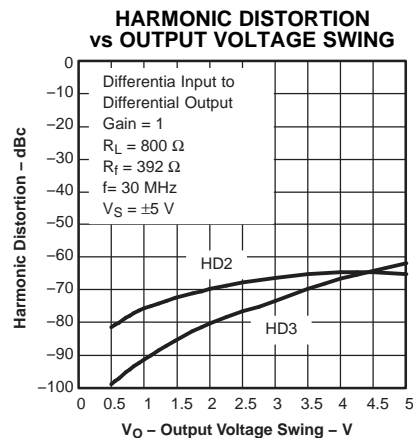

Figure 12.

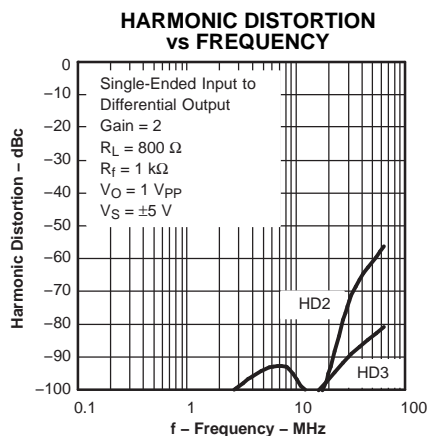

Figure 13.

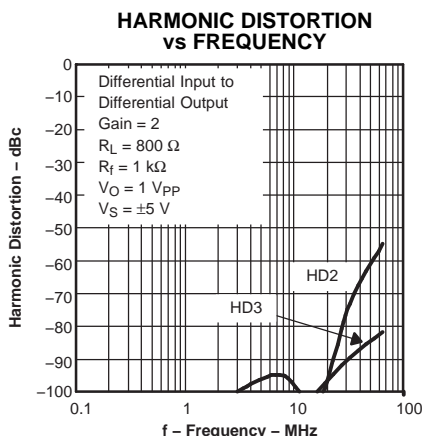

Figure 14.

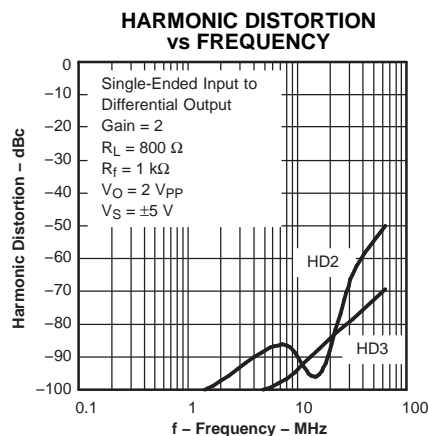

Figure 15.

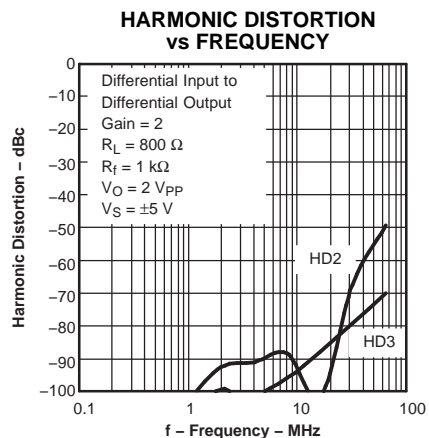

Figure 16.

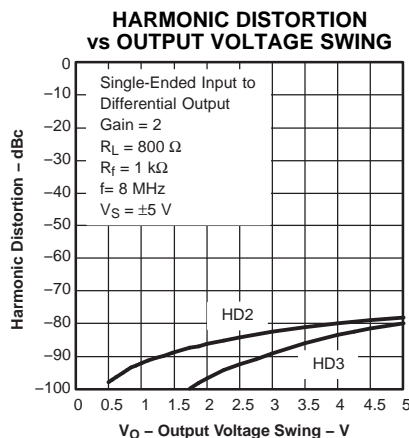

Figure 17.

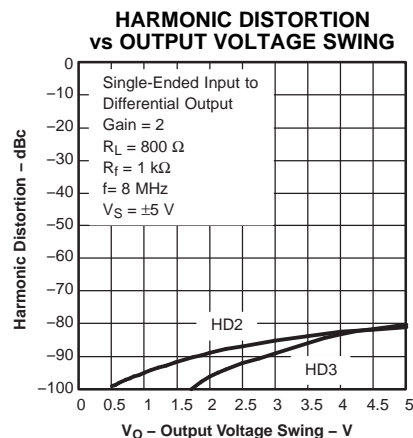

Figure 18.

TYPICAL CHARACTERISTICS:  $\pm 5$  V (continued)

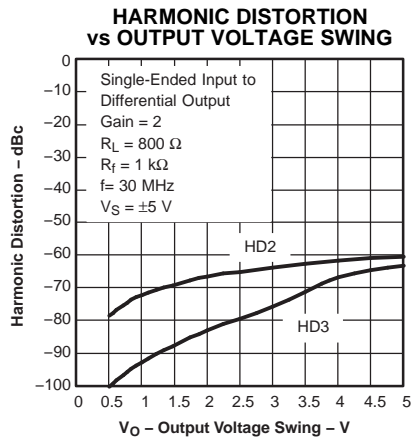

Figure 19.

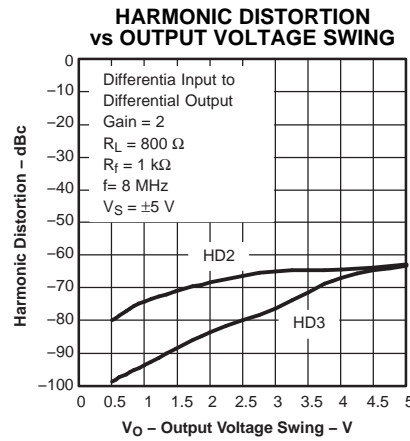

Figure 20.

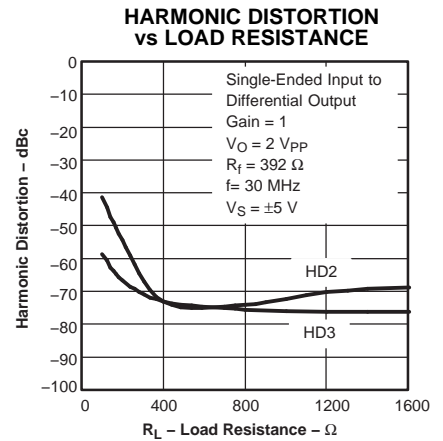

Figure 21.

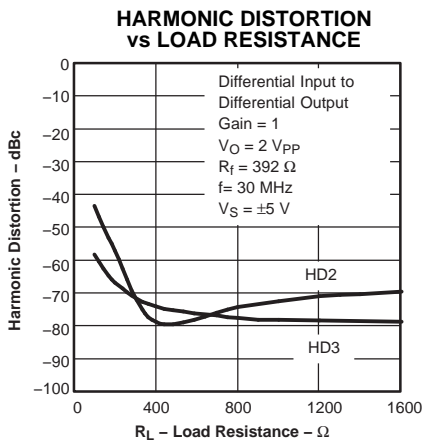

Figure 22.

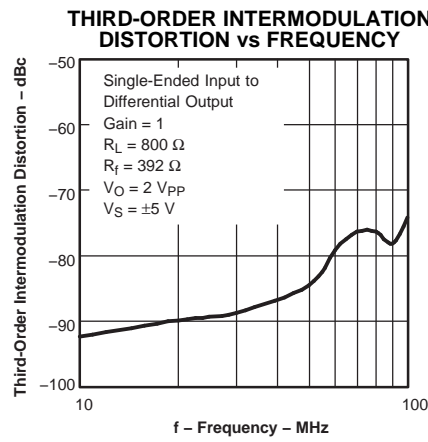

Figure 23.

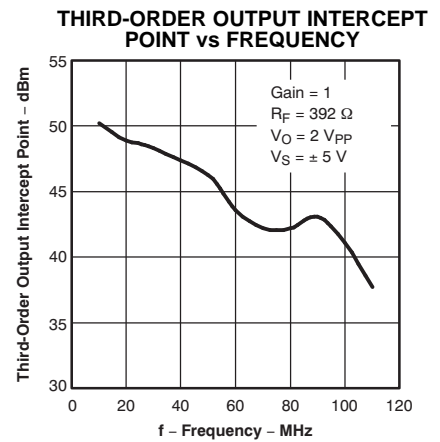

Figure 24.

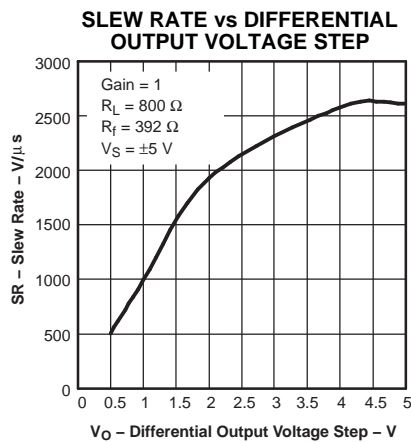

Figure 25.

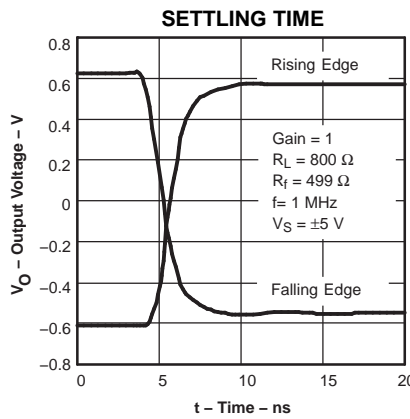

Figure 26.

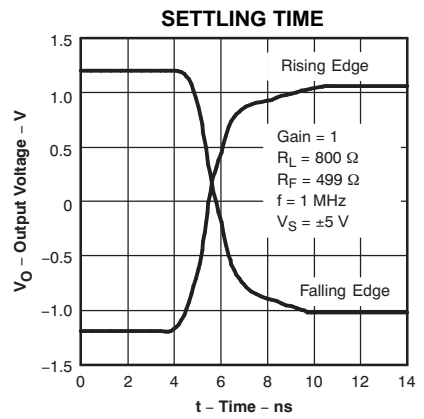

Figure 27.

TYPICAL CHARACTERISTICS: ±5 V (continued)

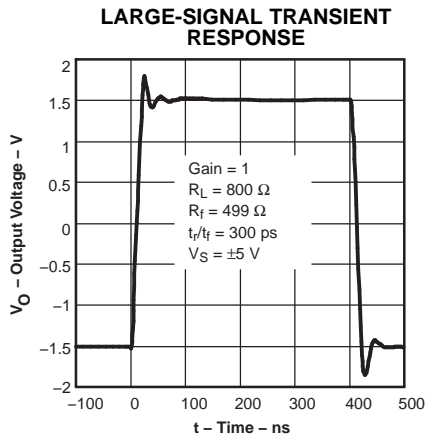

Figure 28.

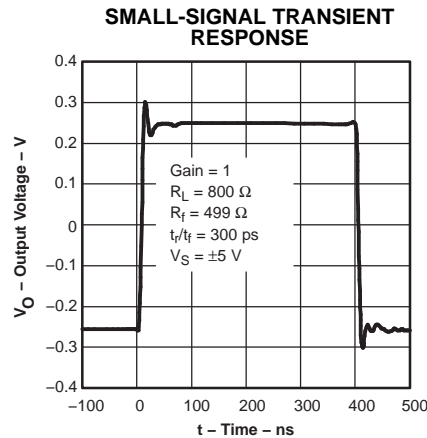

Figure 29.

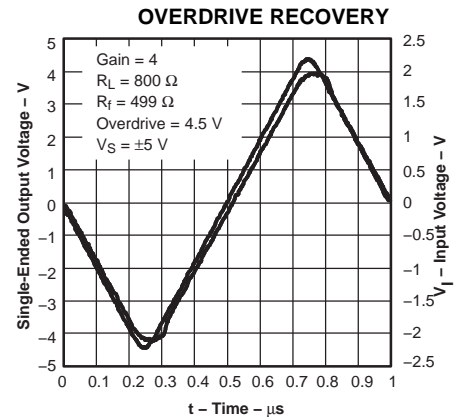

Figure 30.

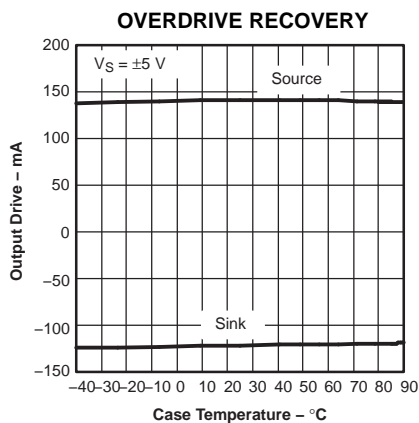

Figure 31.

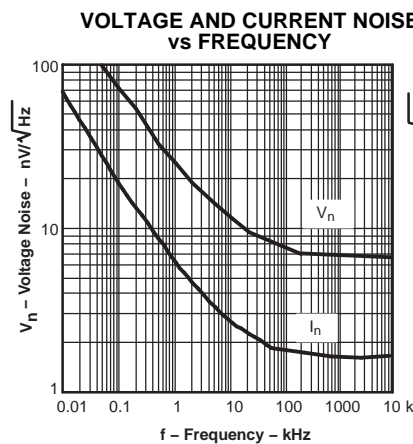

Figure 32.

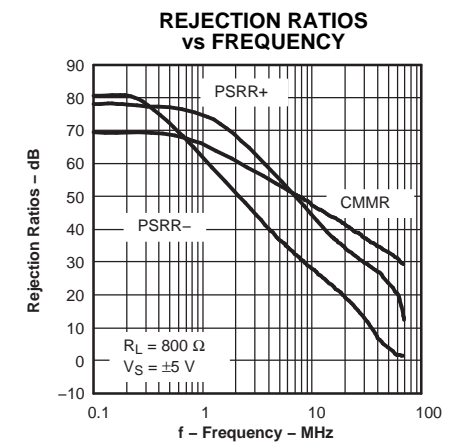

Figure 33.

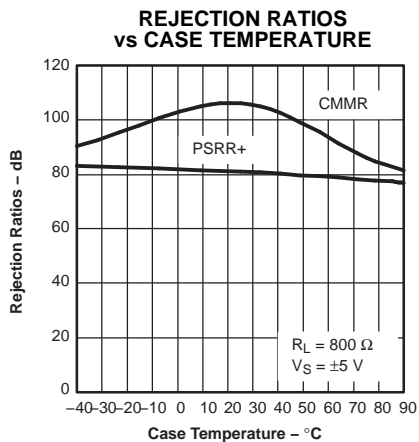

Figure 34.

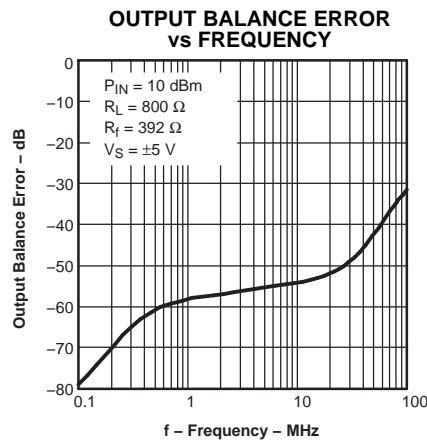

Figure 35.

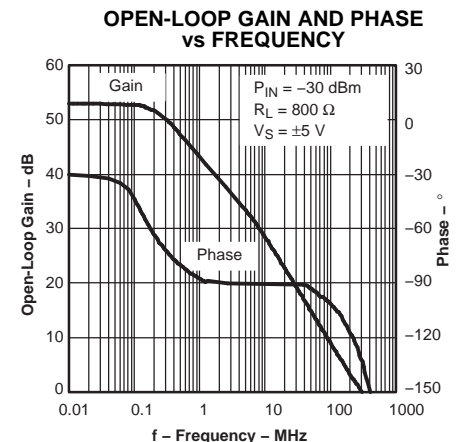

Figure 36.

TYPICAL CHARACTERISTICS: ±5 V (continued)

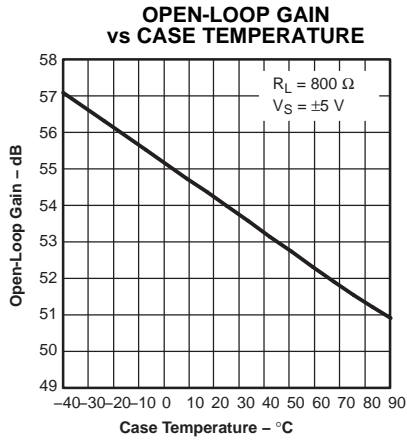

Figure 37.

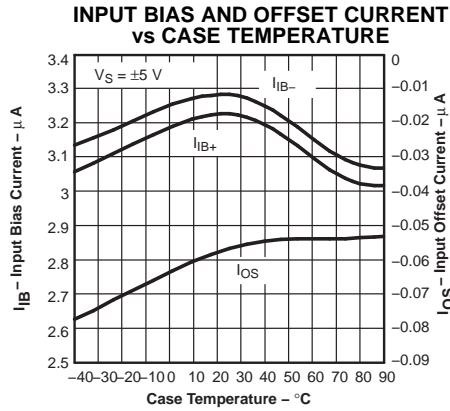

Figure 38.

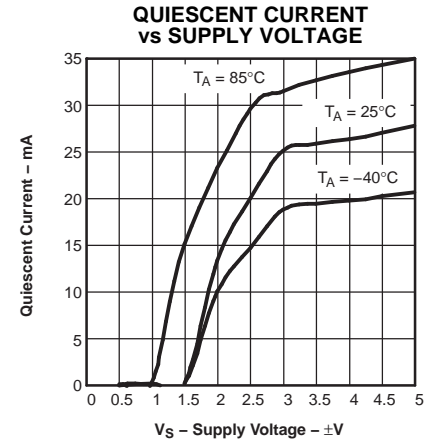

Figure 39.

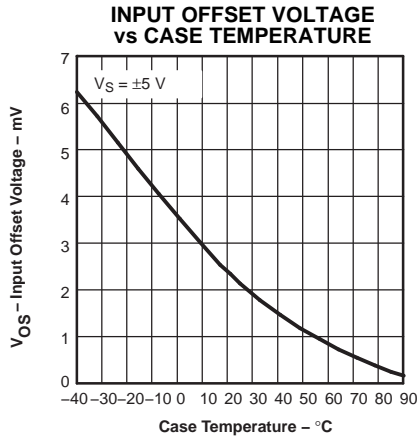

Figure 40.

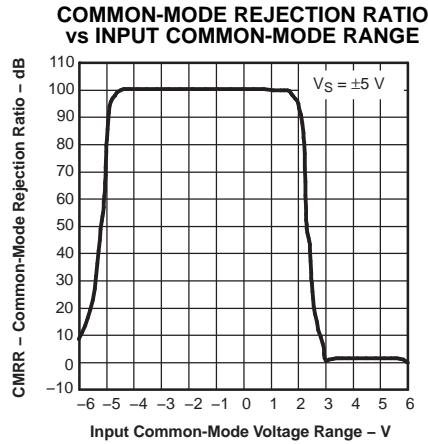

Figure 41.

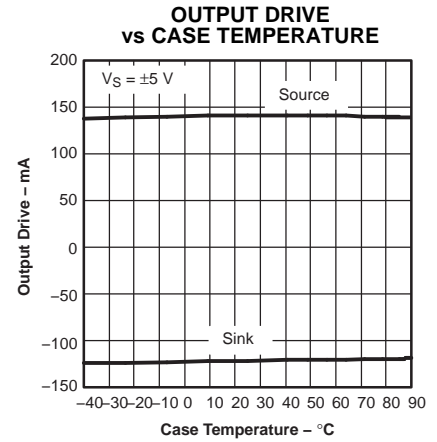

Figure 42.

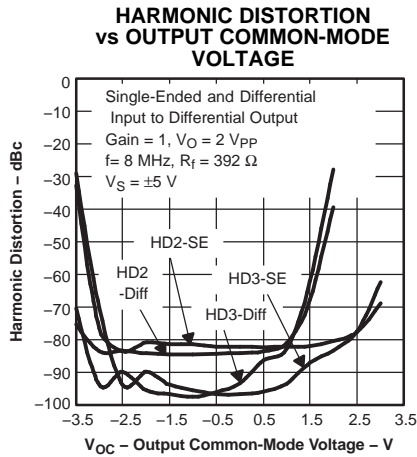

Figure 43.

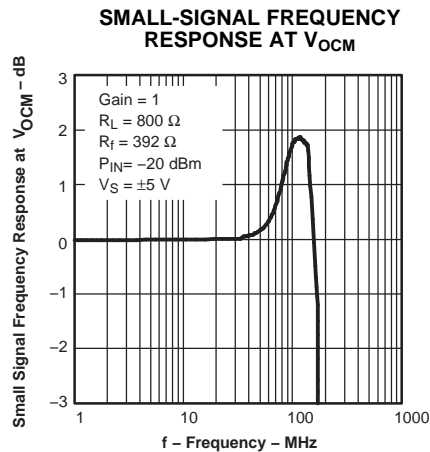

Figure 44.

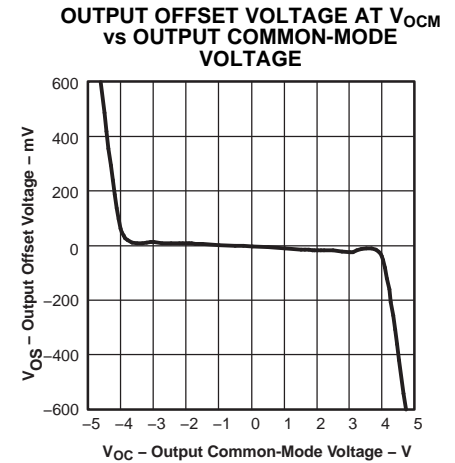

Figure 45.

TYPICAL CHARACTERISTICS: ±5 V (continued)

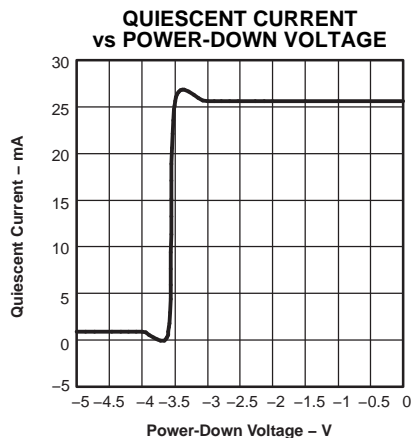

Figure 46.

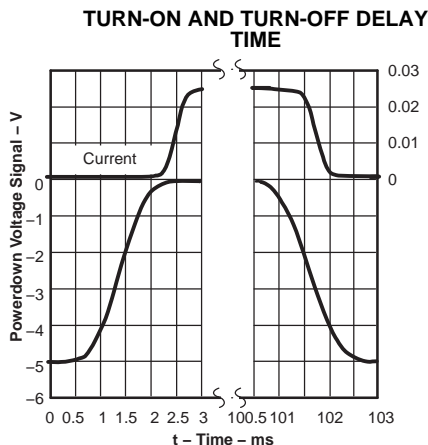

Figure 47.

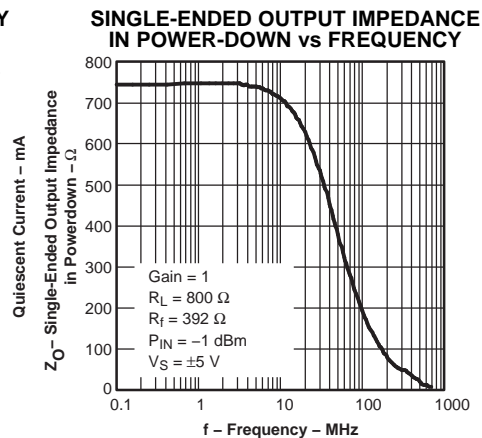

Figure 48.

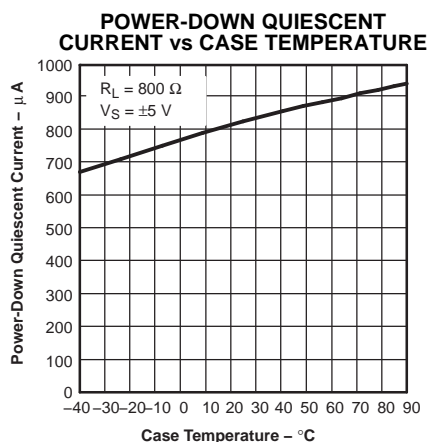

Figure 49.

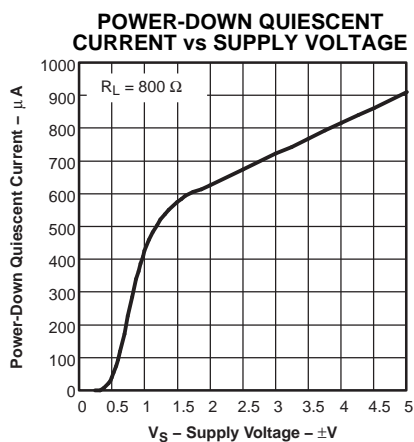

Figure 50.

TYPICAL CHARACTERISTICS: 5 V

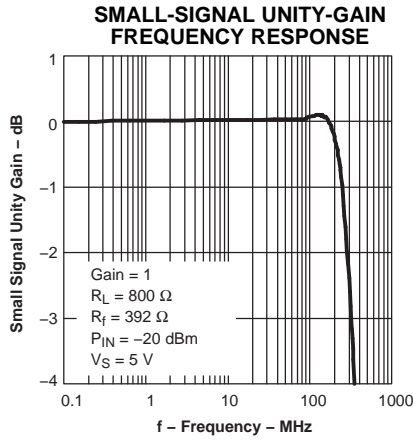

Figure 51.

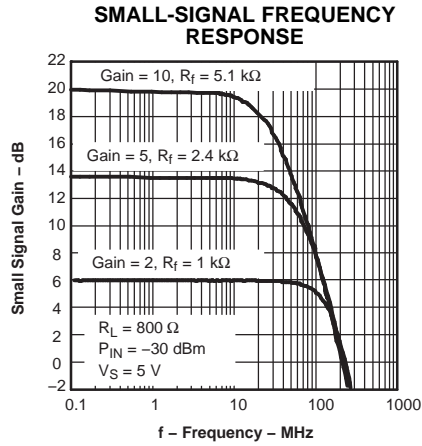

Figure 52.

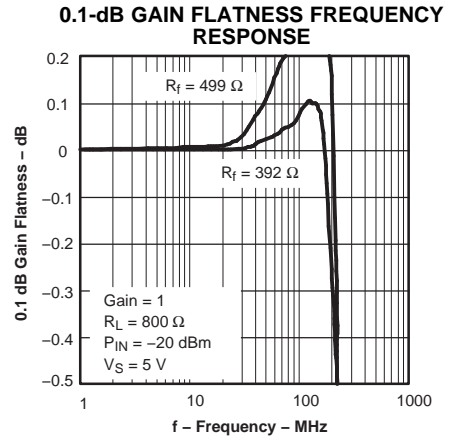

Figure 53.

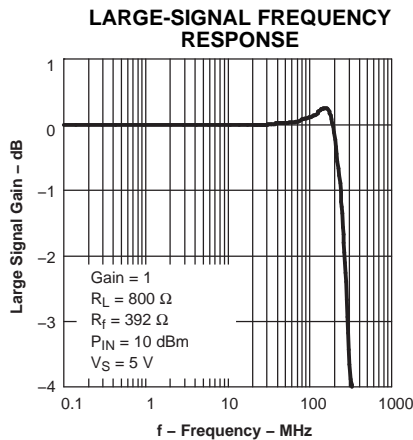

Figure 54.

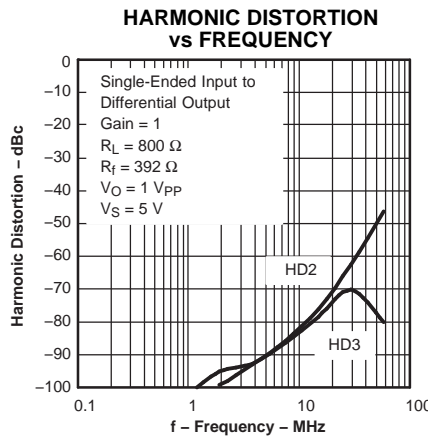

Figure 55.

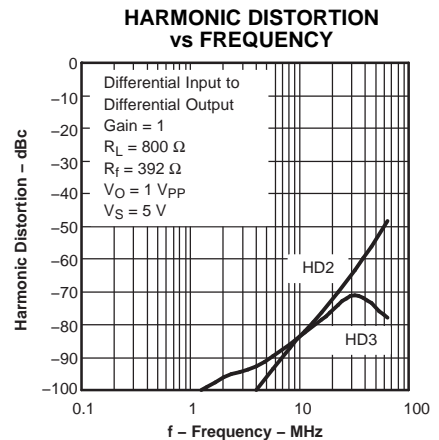

Figure 56.

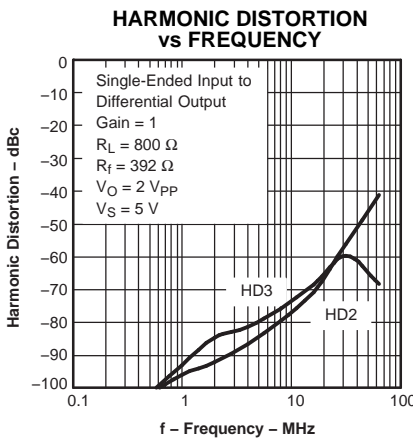

Figure 57.

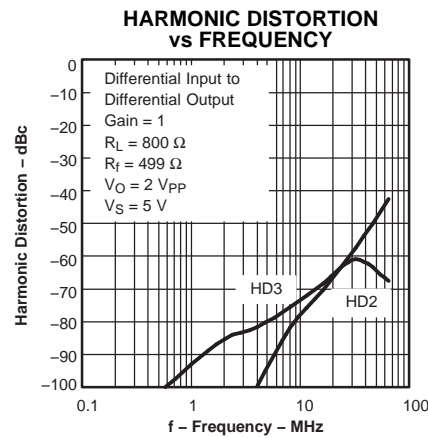

Figure 58.

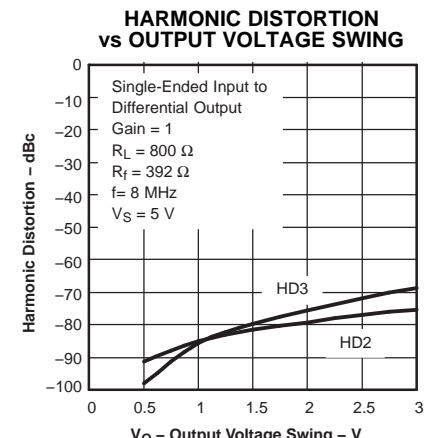

Figure 59.



TYPICAL CHARACTERISTICS: 5 V (continued)

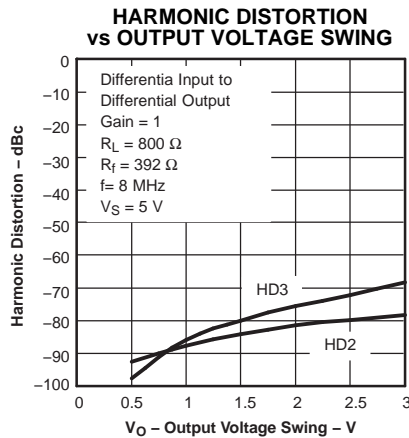

Figure 60.

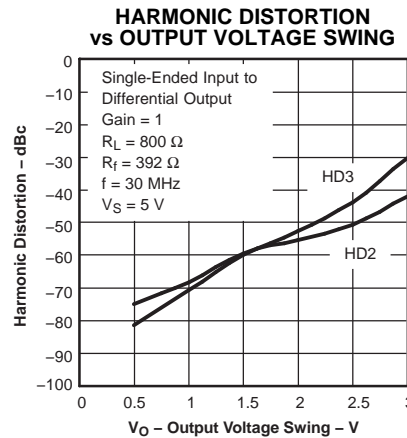

Figure 61.

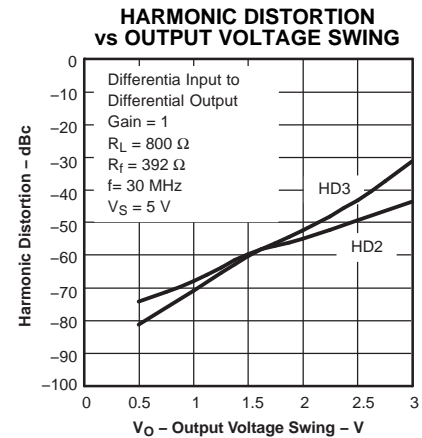

Figure 62.

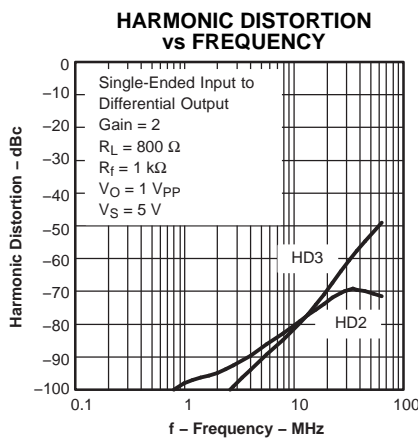

Figure 63.

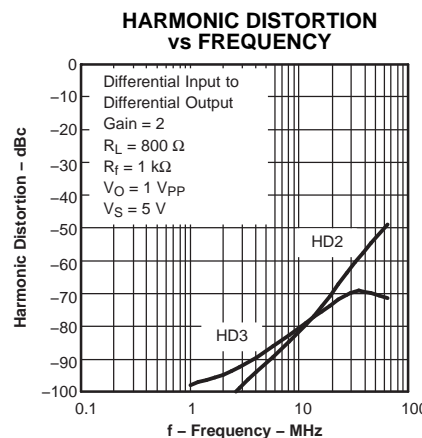

Figure 64.

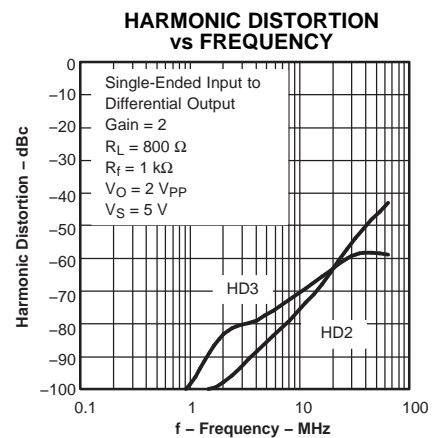

Figure 65.

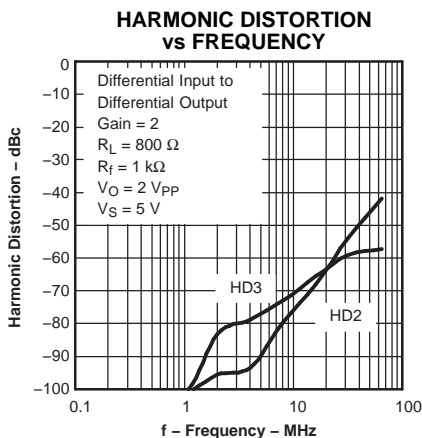

Figure 66.

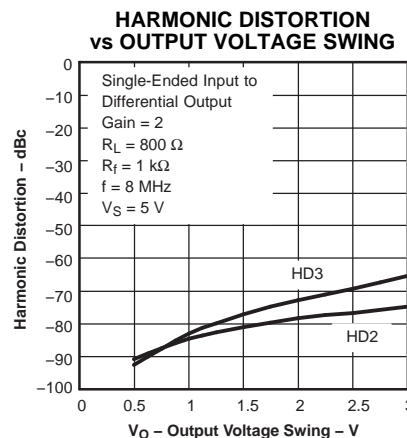

Figure 67.

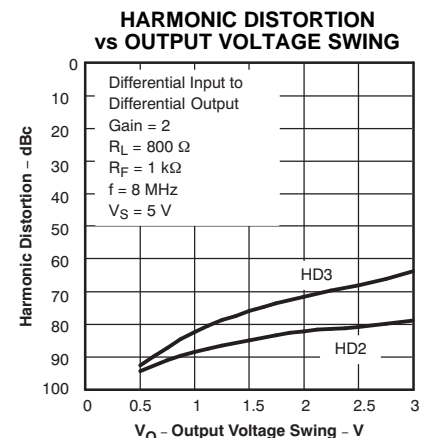

Figure 68.

TYPICAL CHARACTERISTICS: 5 V (continued)

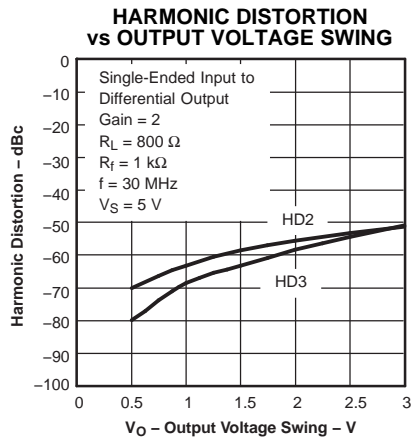

Figure 69.

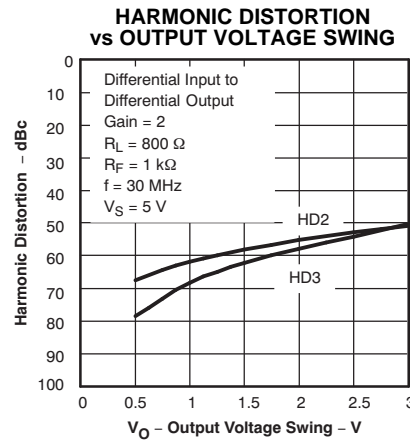

Figure 70.

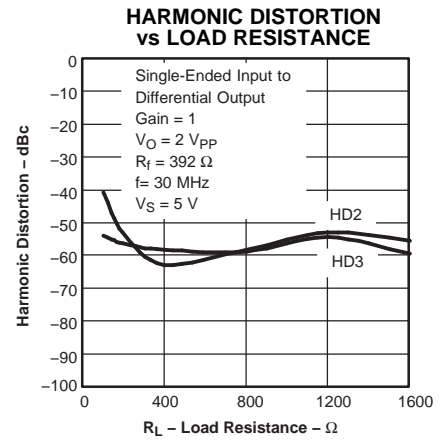

Figure 71.

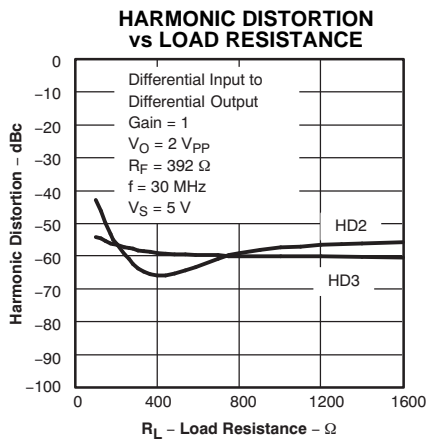

Figure 72.

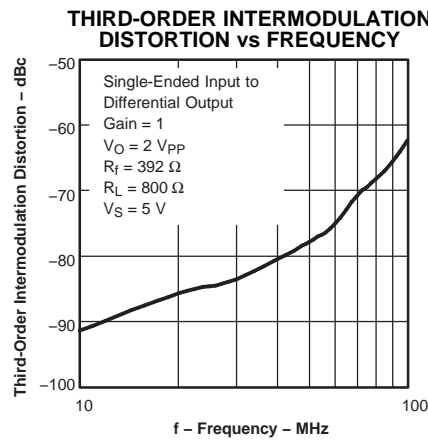

Figure 73.

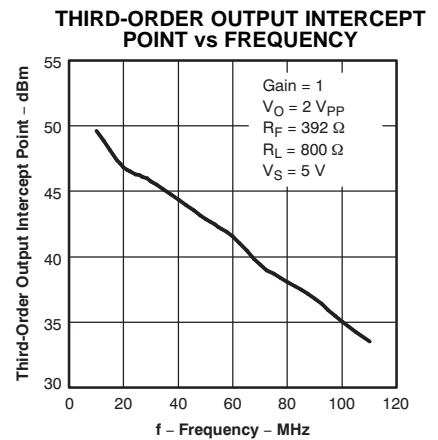

Figure 74.

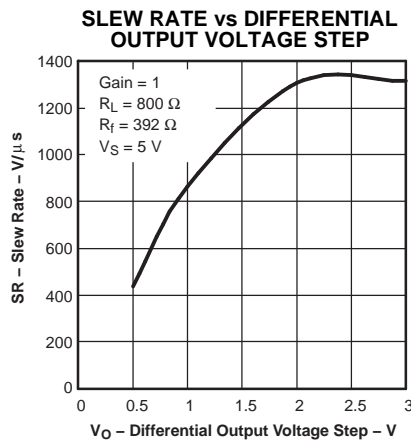

Figure 75.

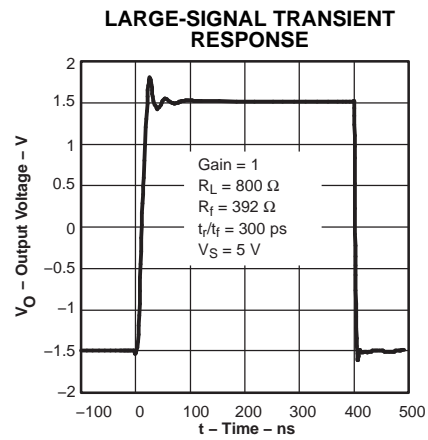

Figure 76.

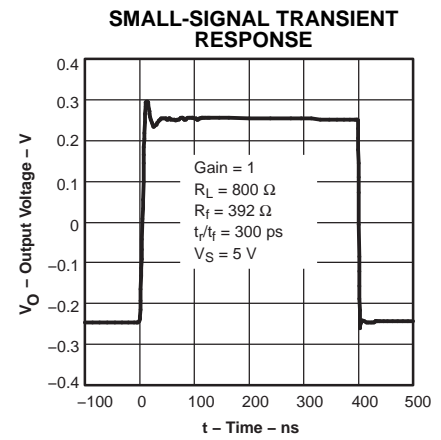

Figure 77.

TYPICAL CHARACTERISTICS: 5 V (continued)

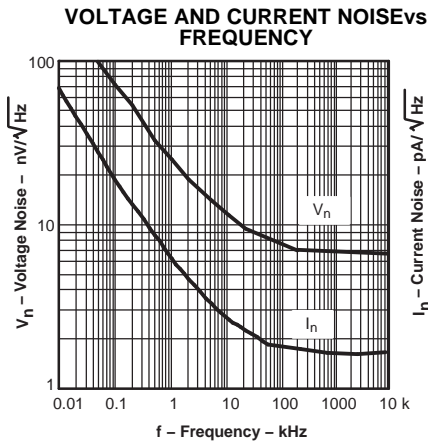

Figure 78.

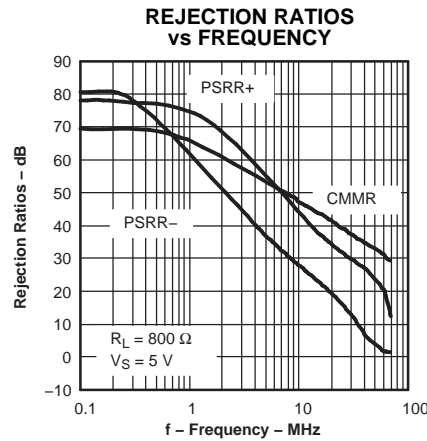

Figure 79.

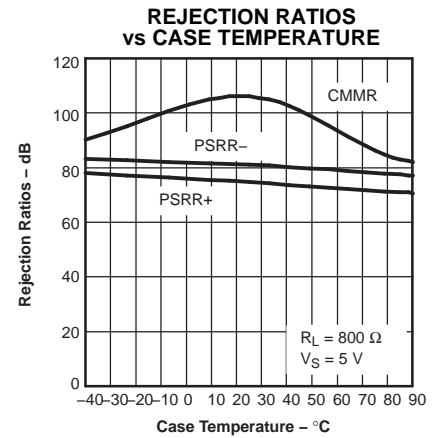

Figure 80.

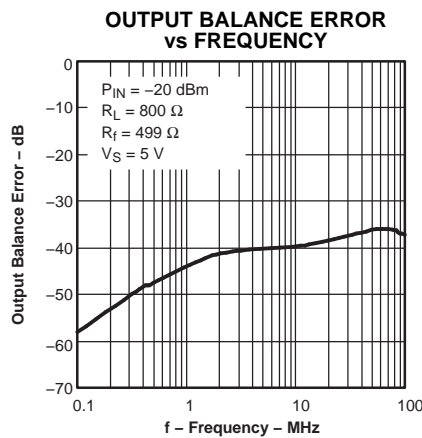

Figure 81.

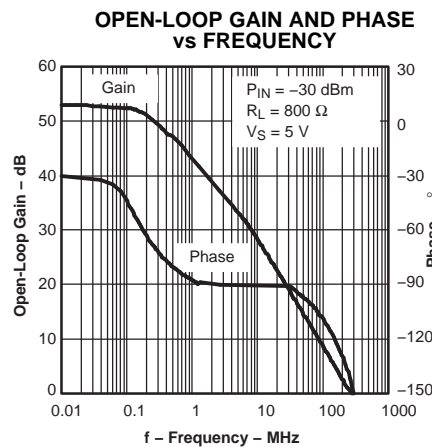

Figure 82.

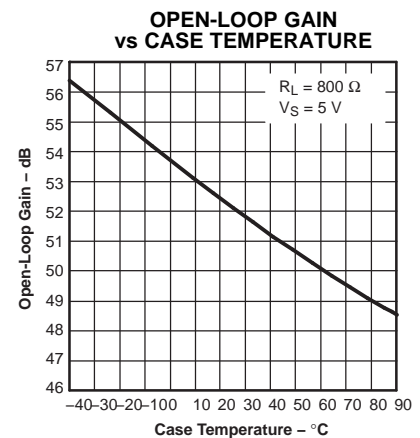

Figure 83.

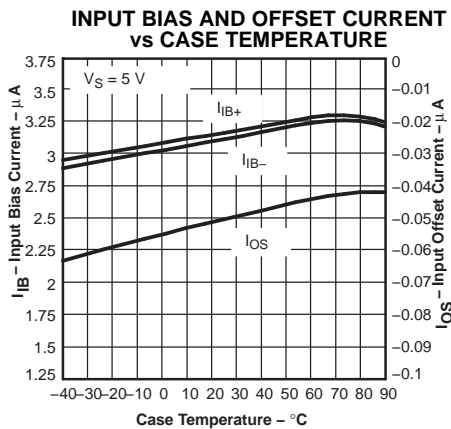

Figure 84.

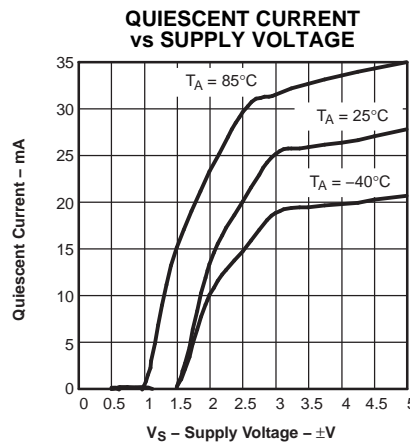

Figure 85.

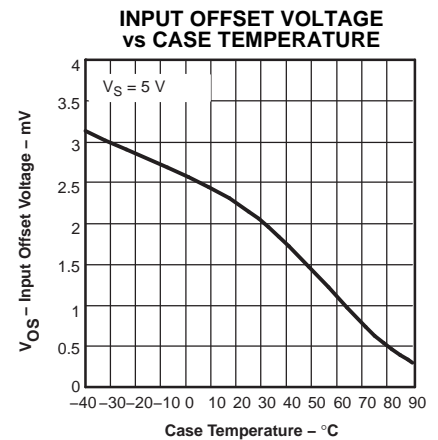

Figure 86.

TYPICAL CHARACTERISTICS: 5 V (continued)

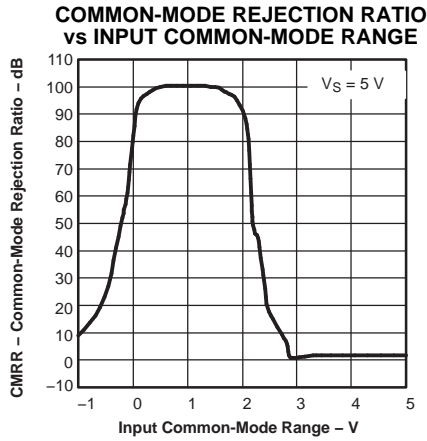

Figure 87.

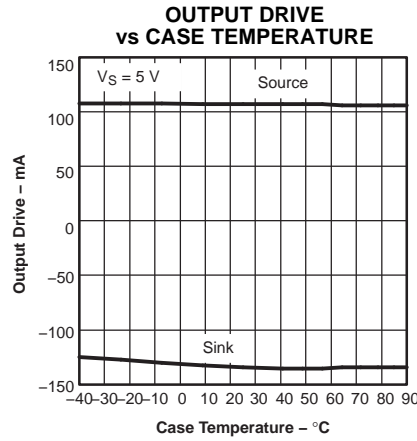

Figure 88.

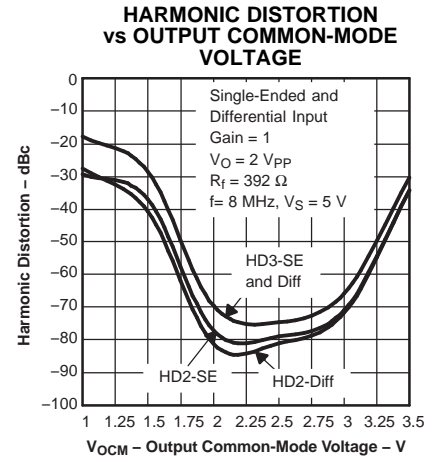

Figure 89.

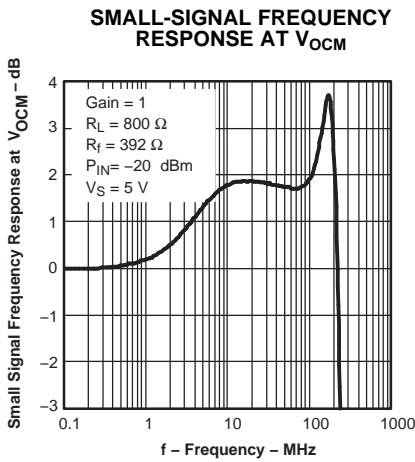

Figure 90.

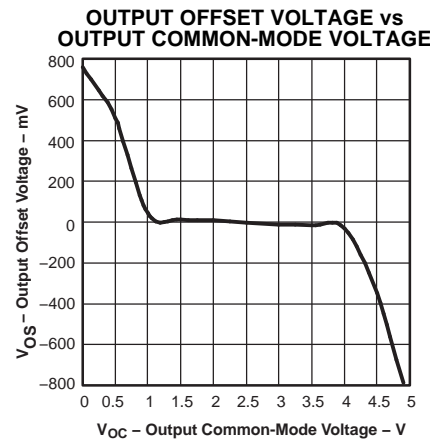

Figure 91.

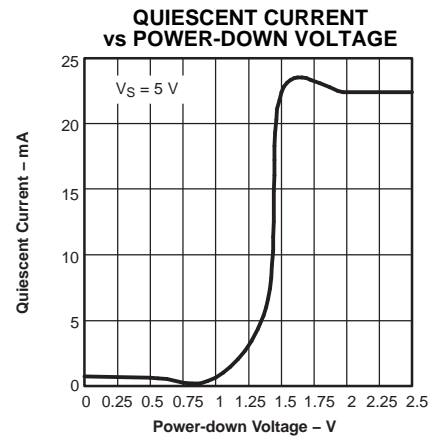

Figure 92.

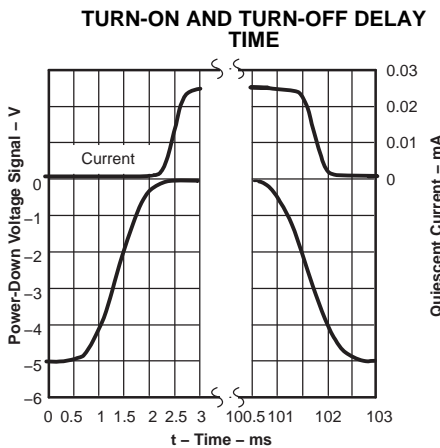

Figure 93.

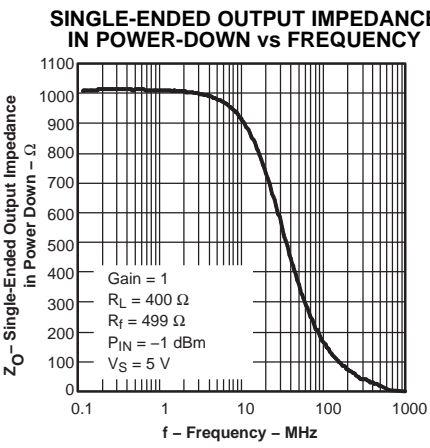

Figure 94.

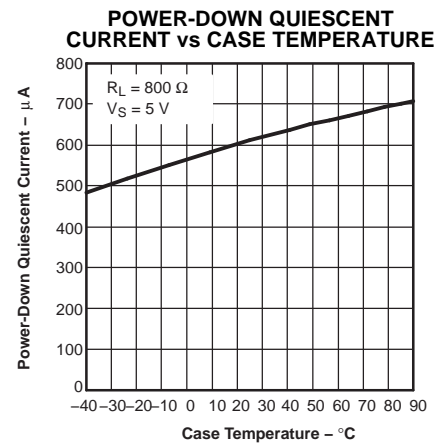

Figure 95.

### TYPICAL CHARACTERISTICS: 5 V (continued)

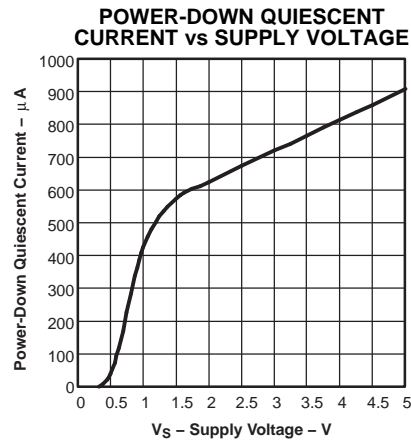

Figure 96.

## APPLICATION INFORMATION

### FULLY DIFFERENTIAL AMPLIFIERS

Differential signaling offers a number of performance advantages in high-speed analog signal processing systems, including immunity to external common-mode noise, suppression of even-order nonlinearities, and increased dynamic range. Fully differential amplifiers not only serve as the primary means of providing gain to a differential signal chain, but also provide a monolithic solution for converting single-ended signals into differential signals for easier, higher performance processing. The THS4500 family of amplifiers contains products in Texas Instruments' expanding line of high-performance, fully differential amplifiers. Information on fully differential amplifier fundamentals, as well as implementation specific information, is presented in the [Applications Section](#) of this data sheet to provide a better understanding of the operation of the THS4500 family of devices, and to simplify the design process for designs using these amplifiers.

### APPLICATIONS SECTION

- Fully Differential Amplifier Terminal Functions
- Input Common-Mode Voltage Range and the THS4500 Family
- Choosing the Proper Value for the Feedback and Gain Resistors
- Application Circuits Using Fully Differential Amplifiers
- Key Design Considerations for Interfacing to an Analog-to-Digital Converter
- Setting the Output Common-Mode Voltage With the  $V_{OCM}$  Input
- Saving Power with Power-Down Functionality
- Linearity: Definitions, Terminology, Circuit Techniques, and Design Tradeoffs
- An Abbreviated Analysis of Noise in Fully Differential Amplifiers
- Printed-Circuit Board Layout Techniques for Optimal Performance
- Power Dissipation and Thermal Considerations
- Power Supply Decoupling Techniques and Recommendations
- Evaluation Fixtures, Spice Models, and Applications Support
- Additional Reference Material

### FULLY DIFFERENTIAL AMPLIFIER TERMINAL FUNCTIONS

Fully differential amplifiers are typically packaged in eight-pin packages, as shown in [Figure 97](#). The device pins include two inputs ( $V_{IN+}$ ,  $V_{IN-}$ ), two outputs ( $V_{OUT-}$ ,  $V_{OUT+}$ ), two power supplies ( $V_{S+}$ ,  $V_{S-}$ ), an output common-mode control pin ( $V_{OCM}$ ), and an optional power-down pin ( $\overline{PD}$ ).

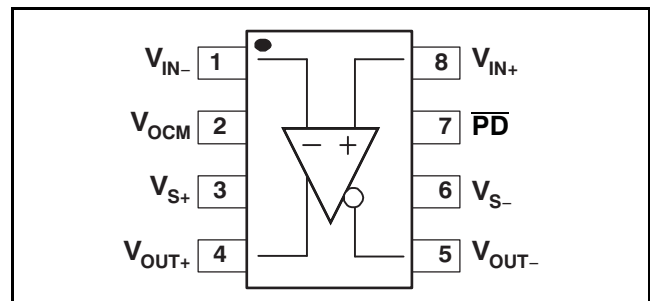

**Figure 97. Fully Differential Amplifier Pin Diagram**

A standard configuration for the device is shown in [Figure 97](#). The functionality of a fully differential amplifier can be imagined as two inverting amplifiers that share a common noninverting terminal (though the voltage is not necessarily fixed). For more information on the basic theory of operation for fully differential amplifiers, refer to the Texas Instruments application note *Fully Differential Amplifiers*, literature number [SLOA054](#), available for download at [www.ti.com](#).

### INPUT COMMON-MODE VOLTAGE RANGE AND THE THS4500 FAMILY

The key difference between the THS4500/1 and the [THS4502/3](#) is the input common-mode range for the four devices. The THS4502 and THS4503 have an input common-mode range that is centered around midrail, and the THS4500 and THS4501 have an input common-mode range that is shifted to include the negative power-supply rail. Selection of one or the other amplifier is determined by the nature of the application. Specifically, the THS4500 and THS4501 are designed for use in single-supply applications where the input signal is ground-referenced, as depicted in [Figure 98](#). The THS4502 and THS4503 are designed for use in single-supply or split-supply applications where the input signal is centered between the power-supply voltages, as depicted in [Figure 99](#).

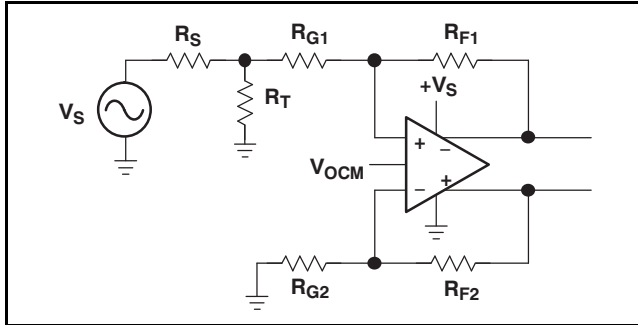

Figure 98. Application Circuit for the THS4500 and THS4501, Featuring Single-Supply Operation With a Ground-Reference Input Signal

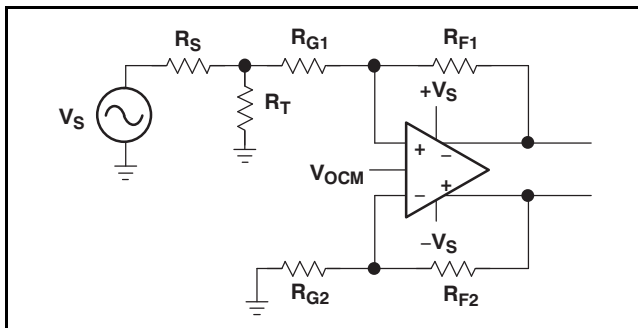

Figure 99. Application Circuit for the THS4500 and THS4501, Featuring Split-Supply Operation With an Input Signal Referenced at the Midrail

Equation 1 through Equation 5 are used to calculate the required input common-mode range for a given set of input conditions.

The equations allow calculation of the input common-mode range requirements, given information about the input signal, the output voltage swing, the gain, and the output common-mode voltage. Calculating the maximum and minimum voltage required for  $V_N$  and  $V_P$  (the amplifier input nodes) determines whether or not the input common-mode range is violated or not. Four equations are required: two calculate the output voltages and two calculate the node voltages at  $V_N$  and  $V_P$  (note that only one of these nodes needs calculation, because the amplifier forces a virtual short between the two nodes).

$$V_{OUT+} = \frac{V_{IN+}(1-\beta) - V_{IN-}(1-\beta) + 2V_{OCM}\beta}{2\beta} \quad (1)$$

$$V_{OUT-} = \frac{-V_{IN+}(1-\beta) + V_{IN-}(1-\beta) + 2V_{OCM}\beta}{2\beta} \quad (2)$$

$$V_N = V_{IN-}(1-\beta) + V_{OUT+}\beta \quad (3)$$

Where:

$$\beta = \frac{R_G}{R_F + R_G} \quad (4)$$

$$V_P = V_{IN+}(1-\beta) + V_{OUT-}\beta \quad (5)$$

NOTE: The equations denote the device inputs as  $V_N$  and  $V_P$ , and the circuit inputs as  $V_{IN+}$  and  $V_{IN-}$ .

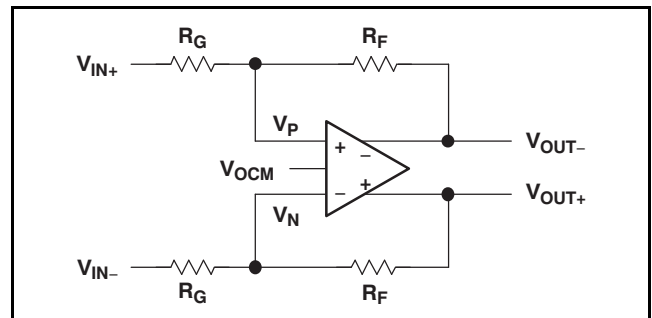

Figure 100. Diagram For Input Common-Mode Range Equations

Table 1 and Table 2 depict the input common-mode range requirements for two different input scenarios, an input referenced around the negative rail and an input referenced around midrail. The tables highlight the differing requirements on input common-mode range, and illustrate the reasoning to choose either the THS4500/1 or the THS4502/3. For signals referenced around the negative power supply, the THS4500/1 should be chosen because its input common-mode range includes the negative supply rail. For all other situations, the THS4502/3 offers slightly improved distortion and noise performance for applications with input signals centered between the power-supply rails.

Table 1. Negative-Rail Referenced

Gain (V/V)	$V_{IN+}$ (V)	$V_{IN-}$ (V)	$V_{IN}$ ( $V_{PP}$ )	$V_{OCM}$ (V)	$V_{OD}$ ( $V_{PP}$ )	$V_{NMIN}$ (V)	$V_{NMAX}$ (V)
1	-2.0 to 2.0	0	4	2.5	4	0.75	1.75
2	-1.0 to 1.0	0	2	2.5	4	0.5	1.167
4	-0.5 to 0.5	0	1	2.5	4	0.3	0.7
8	-0.25 to 0.25	0	0.5	2.5	4	0.167	0.389

**Table 2. Midrail Referenced**

Gain (V/V)	V <sub>IN+</sub> (V)	V <sub>IN-</sub> (V)	V <sub>IN</sub> (V <sub>PP</sub> )	V <sub>OCM</sub> (V)	V <sub>OD</sub> (V <sub>PP</sub> )	V <sub>NMIN</sub> (V)	V <sub>NMAX</sub> (V)
1	0.5 to 4.5	2.5	4	2.5	4	2	3
2	1.5 to 3.5	2.5	2	2.5	4	2.16	2.83
4	2.0 to 3.0	2.5	1	2.5	4	2.3	2.7
8	2.25 to 2.75	2.5	0.5	2.5	4	2.389	2.61

### CHOOSING THE PROPER VALUE FOR THE FEEDBACK AND GAIN RESISTORS

The selection of feedback and gain resistors impacts circuit performance in a number of ways. The values presented in this section provide the optimum high-frequency performance (lowest distortion, flat frequency response). Since the THS4500 family of amplifiers is developed with a voltage feedback architecture, the choice of resistor values does not have a dominant effect on bandwidth, unlike a current-feedback amplifier. However, resistor choices do have second-order effects. For optimal performance, the following feedback resistor values are recommended. In higher gain configurations (gain greater than two), the feedback resistor values have much less effect on the high-frequency performance. Example feedback and gain resistor values are given in the section on basic design considerations (Table 3).

Amplifier loading, noise, and the flatness of the frequency response are three design parameters that should be considered when selecting feedback resistors. Larger resistor values contribute more noise and can induce peaking in the ac response in low gain configurations; smaller resistor values can load the amplifier more heavily, resulting in a reduction in distortion performance. In addition, feedback resistor values, coupled with gain requirements, determine the value of the gain resistors and directly impact the input impedance of the entire circuit. While there are no strict rules about resistor selection, these trends can provide qualitative design guidance.

### APPLICATION CIRCUITS USING FULLY DIFFERENTIAL AMPLIFIERS

Fully differential amplifiers provide designers with a great deal of flexibility in a wide variety of applications. This section provides an overview of some common circuit configurations and gives some design guidelines. Designing the interface to an analog-to-digital converter (ADC), driving lines differentially, and filtering with fully differential amplifiers are a few of the circuits that are covered.

### BASIC DESIGN CONSIDERATIONS

The circuits in Figure 98 through Figure 100 are used to highlight basic design considerations for fully differential amplifier circuit designs.

**Table 3. Resistor Values for Balanced Operation in Various Gain Configurations**

Gain ( $\frac{V_{OD}}{V_{IN}}$ )	R2 and R4 (Ω)	R1 (Ω)	R3 (Ω)	R <sub>T</sub> (Ω)
1	392	412	383	54.9
1	499	523	487	53.6
2	392	215	187	60.4
2	1.3 k	665	634	52.3
5	1.3 k	274	249	56.2
5	3.32 k	681	649	52.3
10	1.3 k	147	118	64.9
10	6.81 k	698	681	52.3

Equations for calculating fully differential amplifier resistor values in order to obtain balanced operation in the presence of a 50-Ω source impedance are given in Equation 6 through Equation 9.

$$R_T = \frac{1}{\frac{1}{R_S} - \frac{K}{2(1+K)}} \quad K = \frac{R_2}{R_1} \quad R_2 = R_4 \quad R_3 = R_1 - (R_S \parallel R_T) \quad (6)$$

$$\beta_1 = \frac{R_1}{R_1 + R_2} \quad \beta_2 = \frac{R_3 + R_T \parallel R_S}{R_3 + R_T \parallel R_S + R_4} \quad (7)$$

$$\frac{V_{OD}}{V_S} = 2 \left( \frac{1 - \beta_2}{\beta_1 + \beta_2} \right) \left( \frac{R_T}{R_T + R_S} \right) \quad (8)$$

$$\frac{V_{OD}}{V_{IN}} = 2 \left( \frac{1 - \beta_2}{\beta_1 + \beta_2} \right) \quad (9)$$

For more detailed information about balance in fully differential amplifiers, see the application report, *Fully Differential Amplifiers (SLOA054)*, referenced at the end of this data sheet.



## INTERFACING TO AN ANALOG-TO-DIGITAL CONVERTER

The THS4500 family of amplifiers are designed specifically to interface to today's highest-performance ADCs. This section highlights the key concerns when interfacing to an ADC and provides example interface circuits.

There are several key design concerns when interfacing to an analog-to-digital converter:

- Terminate the input source properly. In high-frequency receiver chains, the source that feeds the fully differential amplifier requires a specific load impedance (that is, 50 Ω).
- Design a symmetric printed circuit board (PCB) layout. Even-order distortion products are heavily influenced by layout, and careful attention to a symmetric layout minimizes these distortion products.
- Minimize inductance in power-supply decoupling traces and components. Poor power-supply decoupling can have a dramatic effect on circuit performance. Since the outputs are differential, differential currents exist in the power-supply pins. Thus, decoupling capacitors should be placed in a manner that minimizes the impedance of the current loop.
- Use separate analog and digital power supplies and grounds. Noise (bounce) in the power supplies (created by digital switching currents) can couple directly into the signal path, and power-supply noise can create higher distortion products as well.
- Use care when filtering. While an RC low-pass filter may be desirable on the output of the amplifier to filter broadband noise, the excess loading can negatively impact the amplifier linearity. Filtering in the feedback path does not have this effect.
- AC-coupling allows easier circuit design. If dc-coupling is required, be aware of the excess power dissipation that can occur due to level-shifting the output through the output common-mode voltage control.
- Do not terminate the output unless required. Many open-loop, class-A amplifiers require 50-Ω termination for proper operation, but closed-loop fully differential amplifiers drive a specific output voltage regardless of the load impedance present. Terminating the output of a fully differential amplifier with a heavy load adversely affects the amplifier linearity.
- Comprehend the  $V_{OCM}$  input drive requirements. Determine if the ADC voltage reference can provide the required amount of current to move  $V_{OCM}$  to the desired value. A buffer may be needed.

- Decouple the  $V_{OCM}$  pin to eliminate the antenna effect.  $V_{OCM}$  is a high-impedance node that can act as an antenna. A large decoupling capacitor on this node eliminates this problem.
- Know the input common-mode range. If the input signal is referenced around the negative power-supply rail (for example, around ground on a single 5 V supply), then the THS4500/1 accommodates the input signal. If the input signal is referenced around midrail, choose the THS4502/3 for the best operation.
- Packaging makes a difference at higher frequencies. If possible, choose the smaller, thermally-enhanced MSOP package for the best performance. As a rule, lower junction temperatures provide better performance. If possible, use a thermally-enhanced package, even if the power dissipation is relatively small compared to the maximum power dissipation rating to achieve the best results.
- Understand the effect of the load impedance seen by the fully differential amplifier when performing system-level intercept point calculations. Lighter loads (such as those presented by an ADC) allow smaller intercept points to support the same level of intermodulation distortion performance.

## EXAMPLE ANALOG-TO-DIGITAL CONVERTER DRIVER CIRCUITS

The THS4500 family of devices is designed to drive high-performance ADCs with extremely high linearity, allowing for the maximum effective number of bits at the output of the data converter. Two representative circuits shown below highlight single-supply operation and split supply operation, respectively. Specific feedback resistor, gain resistor, and feedback capacitor values are not shown, as these values depend on the frequency of interest. Information on calculating these values can be found in the applications material above.

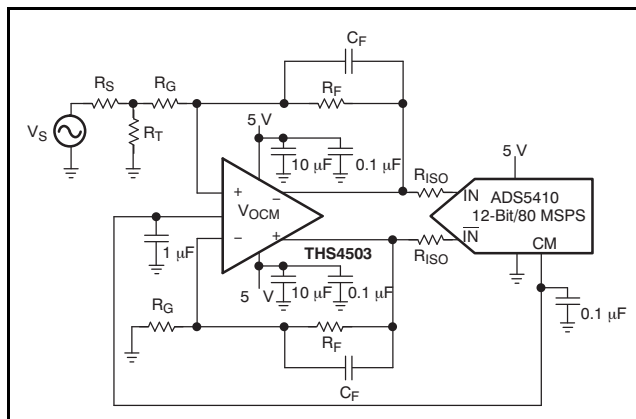

Figure 101. Using the THS4503 With the [ADS5410](#)

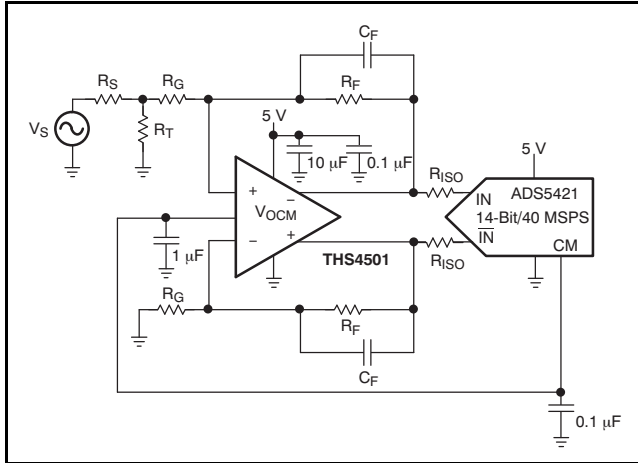

Figure 102. Using the THS4501 With the ADS5421

### FULLY DIFFERENTIAL LINE DRIVERS

The THS4500 family of amplifiers can be used as high-frequency, high-swing differential line drivers. The high power-supply voltage rating (16.5 V absolute maximum) allows operation on a single 12-V or a single 15-V supply. The high supply voltage, coupled with the ability to provide differential outputs, enables the ability to drive 26 V<sub>PP</sub> into reasonably heavy loads (250 Ω or greater). The circuit in Figure 103 illustrates the THS4500 family of devices used as high-speed line drivers. For line driver applications, close attention must be paid to thermal design constraints because of the typically high level of power dissipation.

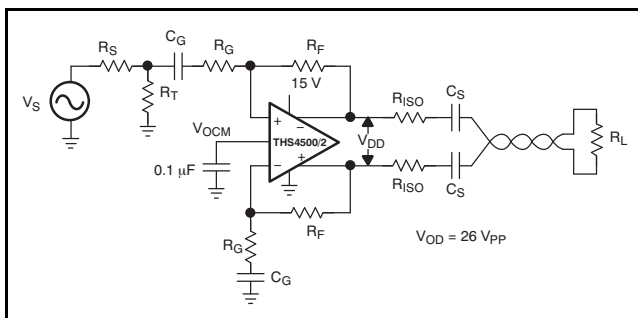

Figure 103. Fully Differential Line Driver With High Output Swing

### FILTERING WITH FULLY DIFFERENTIAL AMPLIFIERS

Similar to single-ended counterparts, fully differential amplifiers have the ability to couple filtering functionality with voltage gain. Numerous filter topologies can be based on fully differential amplifiers. Several of these are outlined in the application report *A Differential Circuit Collection* (literature number SLOA064), referenced at the end of this data sheet. The circuit below depicts a simple, two-pole, low-pass filter applicable to many different types of systems. The first pole is set by the resistors and capacitors in the feedback paths, and the second pole is set by the isolation resistors and the capacitor across the outputs of the isolation resistors.

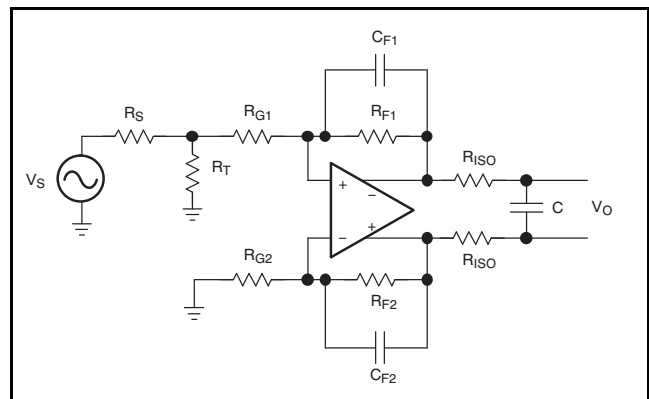

Figure 104. A Two-Pole, Low-Pass Filter Design Using a Fully Differential Amplifier With Poles Located at:  $P1 = (2\pi R_F C_F)^{-1}$  in Hz and  $P2 = (4\pi R_{ISO} C)^{-1}$  in Hz

Often, filters like these are used to eliminate broadband noise and out-of-band distortion products in signal acquisition systems. It should be noted that the increased load placed on the output of the amplifier by the second low-pass filter has a detrimental effect on the distortion performance. The preferred method of filtering is to use the feedback network, as the typically smaller capacitances required at these points in the circuit do not load the amplifier nearly as heavily in the passband.

## SETTING THE OUTPUT COMMON-MODE VOLTAGE WITH THE $V_{OCM}$ INPUT

The output common-mode voltage pin provides a critical function to the fully differential amplifier; it accepts an input voltage and reproduces that input voltage as the output common-mode voltage. In other words, the  $V_{OCM}$  input provides the ability to level-shift the outputs to any voltage inside the output voltage swing of the amplifier.

A description of the input circuitry of the  $V_{OCM}$  pin is shown in Figure 105 to facilitate an easier understanding of the  $V_{OCM}$  interface requirements. The  $V_{OCM}$  pin has two 50-k $\Omega$  resistors between the power supply rails to set the default output common-mode voltage to midrail. A voltage applied to the  $V_{OCM}$  pin alters the output common-mode voltage as long as the source has the ability to provide enough current to overdrive the two 50-k $\Omega$  resistors. This phenomenon is depicted in the  $V_{OCM}$  equivalent circuit diagram. Current drive is especially important when using the reference voltage of an analog-to-digital converter to drive  $V_{OCM}$ . Output current drive capabilities differ from part to part, so a voltage buffer may be necessary in some applications.

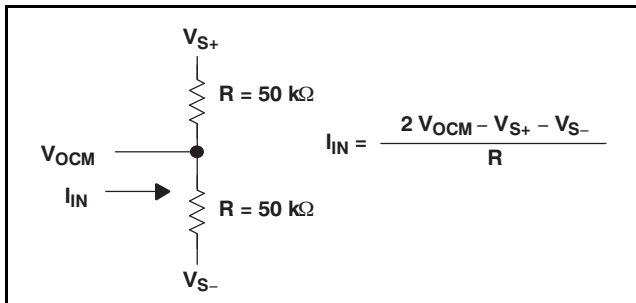

Figure 105. Equivalent Input Circuit for  $V_{OCM}$

By design, the input signal applied to the  $V_{OCM}$  pin propagates to the outputs as a common-mode signal. As shown in Figure 105, the  $V_{OCM}$  input has a high impedance associated with it, dictated by the two 50-k $\Omega$  resistors. While the high impedance allows for relaxed drive requirements, it also allows the pin and any associated PCB traces to act as an antenna. For this reason, a decoupling capacitor is recommended on this node for the sole purpose of filtering any high-frequency noise that could couple into the signal path through the  $V_{OCM}$  circuitry. A 0.1- $\mu$ F or 1- $\mu$ F capacitance is a reasonable value for eliminating a great deal of broadband interference, but additional, tuned decoupling capacitors should be considered if a specific source of electromagnetic or radio frequency interference is present elsewhere in the system. Information on the ac performance (bandwidth, slew rate) of the  $V_{OCM}$  circuitry is included in the [Electrical Characteristics](#) and [Typical Characteristics](#) sections.

Since the  $V_{OCM}$  pin provides the ability to set an output common-mode voltage, the ability for increased power dissipation exists. While this possibility does not pose a performance problem for the amplifier, it can cause additional power dissipation of which the system designer should be aware. The circuit shown in Figure 106 demonstrates an example of this phenomenon. For a device operating on a single 5-V supply with an input signal referenced around ground and an output common-mode voltage of 2.5 V, a dc potential exists between the outputs and the inputs of the device. The amplifier sources current into the feedback network in order to provide the circuit with the proper operating point. While there are no serious effects on the circuit performance, the extra power dissipation may need to be included in the system power budget.

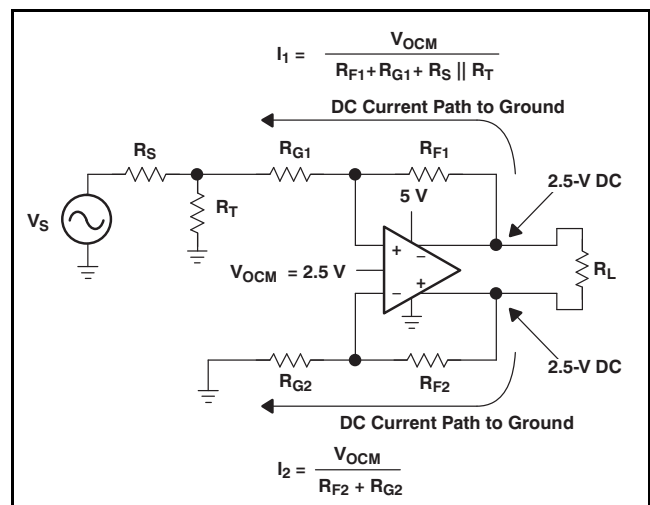

Figure 106. Depiction of DC Power Dissipation Caused By Output Level-Shifting in a DC-Coupled Circuit

## SAVING POWER WITH POWER-DOWN FUNCTIONALITY

The THS4500 family of fully differential amplifiers contains devices that come with and without the power-down option. Even-numbered devices have power-down capability, which is described in detail here.

The power-down pin of the amplifiers defaults to the positive supply voltage in the absence of an applied voltage (that is, an internal pull-up resistor is present), putting the amplifier in the *power-on* mode of operation. To turn off the amplifier in an effort to conserve power, the power-down pin can be driven towards the negative rail. The threshold voltages for power-on and power-down are relative to the supply rails and given in the specification tables. Above the *enable threshold voltage*, the device is on. Below the *disable threshold voltage*, the device is off. Behavior between these threshold voltages is not specified.

Note that this power-down functionality is just that; the amplifier consumes less power in power-down mode. The power-down mode is not intended to provide a high-impedance output. In other words, the power-down functionality is not intended to allow use as a 3-state bus driver. When in power-down mode, the impedance looking back into the output of the amplifier is dominated by the feedback and gain setting resistors.

The time delays associated with turning the device on and off are specified as the time it takes for the amplifier to reach 50% of the nominal quiescent current. The time delays are on the order of microseconds because the amplifier moves in and out of the linear mode of operation in these transitions.

## LINEARITY: DEFINITIONS, TERMINOLOGY, CIRCUIT TECHNIQUES, AND DESIGN TRADEOFFS

The THS4500 family of devices features unprecedented distortion performance for monolithic fully differential amplifiers. This section focuses on the fundamentals of distortion, circuit techniques for reducing nonlinearity, and methods for equating distortion of fully differential amplifiers to desired linearity specifications in RF receiver chains.

Amplifiers are generally thought of as *linear* devices. In other words, the output of an amplifier is a linearly scaled version of the input signal applied to it. In reality, however, amplifier transfer functions are nonlinear. Minimizing amplifier nonlinearity is a primary design goal in many applications.

Intercept points are specifications that have long been used as key design criteria in the RF communications world as a metric for the intermodulation distortion performance of a device in the signal chain (for example, amplifiers, mixers, etc.). Use of the intercept point, rather than strictly the intermodulation distortion, allows for simpler system-level calculations. Intercept points, like noise figures, can be easily cascaded back and forth through a signal chain to determine the overall receiver chain intermodulation distortion performance. The relationship between intermodulation distortion and intercept point is depicted in [Figure 107](#) and [Figure 108](#).

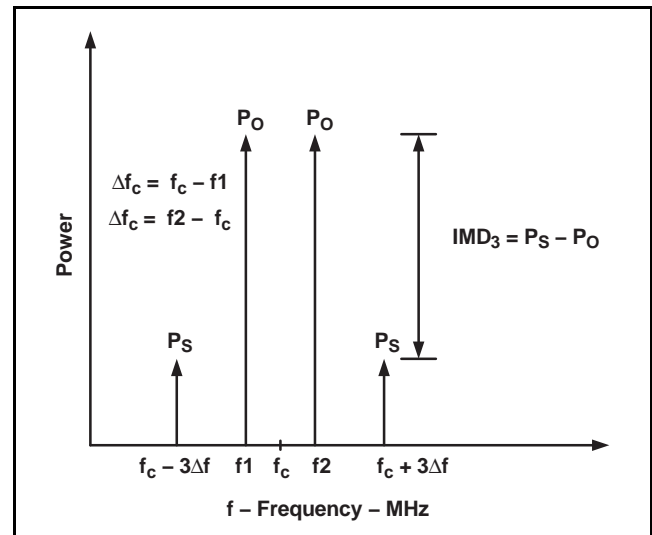
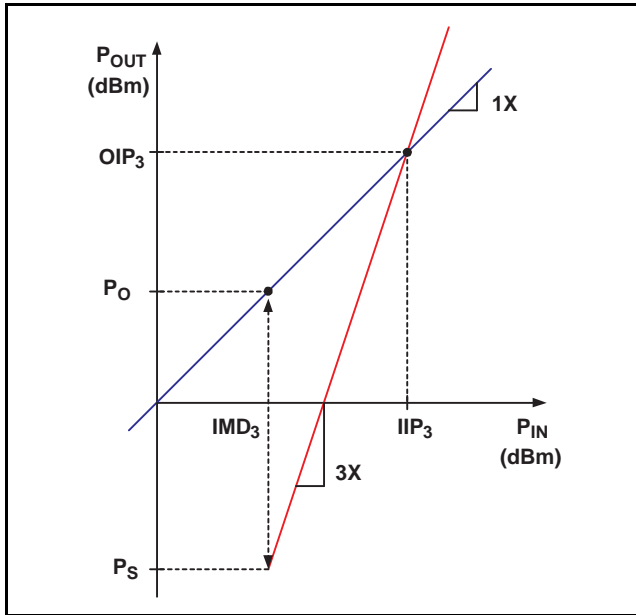

Figure 107. 2-Tone and 3rd-Order Intermodulation Products



**Figure 108. Graphical Representation of 2-Tone and 3rd-Order Intercept Point**

Due to the intercept point ease-of-use in system level calculations for receiver chains, it has become the specification of choice for guiding distortion-related design decisions. Traditionally, these systems use primarily class-A, single-ended RF amplifiers as gain blocks. These RF amplifiers are typically designed to operate in a 50-Ω environment, just like the rest of the receiver chain. Since intercept points are given in dBm, this implies an associated impedance (50 Ω).

However, with a fully differential amplifier, the output does not require termination as an RF amplifier would. Because closed-loop amplifiers deliver signals to the outputs regardless of the impedance present, it is important to comprehend this feature when evaluating the intercept point of a fully differential amplifier. The THS4500 series of devices yields optimum distortion performance when loaded with 200 Ω to 1 kΩ, very similar to the input impedance of an analog-to-digital converter over its input frequency band. As a result, terminating the input of the ADC to 50 Ω can actually be detrimental to system performance.

This discontinuity between open-loop, class-A amplifiers and closed-loop, class-AB amplifiers becomes apparent when comparing the intercept points of the two types of devices. Equation 10 gives the definition of an intercept point, relative to the intermodulation distortion.

$$OIP_3 = P_O + \left( \frac{|IMD_3|}{2} \right) \text{ where} \quad (10)$$

$$P_O = 10 \log \left( \frac{V_{P(diff)}^2}{2R_L \times 0.001} \right)$$

NOTE:  $P_O$  is the output power of a single tone,  $R_L$  is the differential load resistance, and  $V_{P(diff)}$  is the differential peak voltage for a single tone. (11)

As can be seen in the equations, when a higher impedance is used, the same level of intermodulation distortion performance results in a lower intercept point. Therefore, it is important to understand the impedance seen by the output of the fully differential amplifier when selecting a minimum intercept point. Figure 109 shows the relationship between the strict definition of an intercept point with a normalized, or equivalent, intercept point for the THS4500.

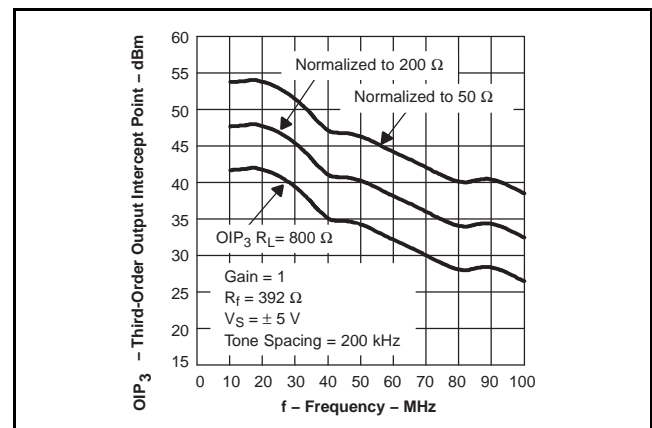

**Figure 109. Equivalent 3rd-Order Intercept Point for the THS4500**

Comparing specifications between different device types becomes easier when a common impedance level is assumed. For this reason, the intercept points on the THS4500 family of devices are reported normalized to a 50-Ω load impedance.

### AN ANALYSIS OF NOISE IN FULLY DIFFERENTIAL AMPLIFIERS

Noise analysis in fully differential amplifiers is analogous to noise analysis in single-ended amplifiers; the same concepts apply. Figure 110 shows a generic circuit diagram consisting of a voltage source, a termination resistor, two gain setting resistors, two feedback resistors, and a fully differential amplifier is shown, including all the relevant noise sources. From this circuit, the noise factor (F) and noise figure (NF) are calculated. The figures indicate the appropriate scaling factor for each of the noise sources in two different cases. The first case includes the termination resistor, and the

second, simplified case assumes that the voltage source is properly terminated by the gain-setting resistors. With these scaling factors, the amplifier input noise power ( $N_A$ ) can be calculated by summing each individual noise source with its scaling factor. The noise delivered to the amplifier by the source ( $N_i$ ) and input noise power are used to calculate the noise factor and noise figure as shown in Equation 23 through Equation 27.

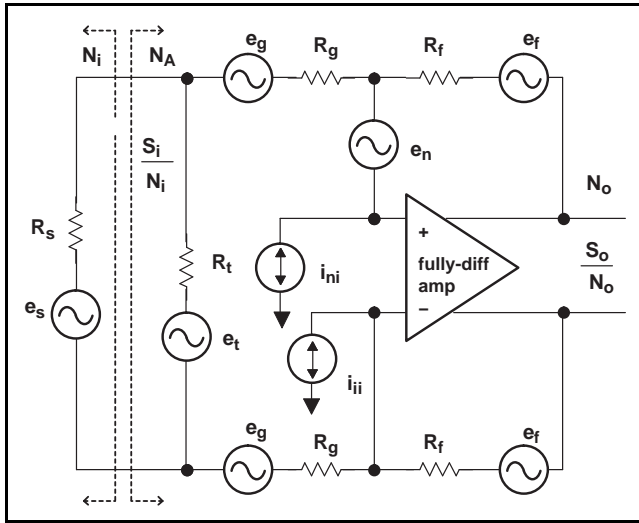

Figure 110. Noise Sources in a Fully Differential Amplifier Circuit

### Scaling Factors for Individual Noise Sources Assuming a Finite Value Termination Resistor

$N_A$ : Fully Differential Amplifier

Noise Source Scale Factor

$$(e_{ni})^2 \left[ \frac{R_g}{R_f} + \frac{R_g}{R_g + \frac{R_s R_t}{2(R_s + R_t)}} \right]^2 \quad (12)$$

$$(i_{ni})^2 R_g^2 \quad (13)$$

$$(i_{ii})^2 R_g^2 \quad (14)$$

$$4kTR_t \left[ \frac{2R_s R_g}{R_s + 2R_g} \right]^2 \left[ \frac{2R_s R_g}{R_t + R_s + 2R_g} \right]^2 \quad (15)$$

$$4kTR_f \cdot 2 \times \left( \frac{R_g}{R_f} \right)^2 \quad (16)$$

$$4kTR_g \cdot 2 \times \left[ \frac{R_g}{R_g + \frac{R_s R_t}{2(R_s + R_t)}} \right]^2 \quad (17)$$

### Scaling Factors for Individual Noise Sources Assuming No Termination Resistance is Used (that is, $R_T$ is Open)

$N_A$ : Fully Differential Amplifier; termination =  $2R_g$

Noise Source Scale Factor

$$(e_{ni})^2 \left[ \frac{R_g}{R_f} + \frac{R_g}{R_g + \frac{R_s}{2}} \right]^2 \quad (18)$$

$$(i_{ni})^2 R_g^2 \quad (19)$$

$$(i_{ii})^2 R_g^2 \quad (20)$$

$$4kTR_f \cdot 2 \times \left( \frac{R_g}{R_f} \right)^2 \quad (21)$$

$$4kTR_g \cdot 2 \times \left[ \frac{R_g}{R_g + \frac{R_s}{2}} \right]^2 \quad (22)$$

### Input Noise With a Termination Resistor

$$N_i = 4kTR_s \left[ \frac{2R_t R_g}{R_t + 2R_g} \right]^2 \left[ \frac{2R_t R_g}{R_s + \frac{R_t + 2R_g}{2}} \right]^2 \quad (23)$$

### Input Noise Assuming No Termination Resistor

$$N_i = 4kTR_s \left[ \frac{2R_g}{R_s + 2R_g} \right]^2 \quad (24)$$

### Noise Factor and Noise Figure Calculations

$$N_A = \sum(\text{Noise Source} \times \text{Scale Factor}) \quad (25)$$

$$F = 1 + \frac{N_A}{N_i} \quad (26)$$

$$NF = 10 \log (F) \quad (27)$$

## PRINTED CIRCUIT BOARD LAYOUT TECHNIQUES FOR OPTIMAL PERFORMANCE

Achieving optimum performance with high frequency amplifier-like devices in the THS4500 family requires careful attention to PCB layout parasitic and external component types.

Recommendations that optimize performance include:

- Minimize parasitic capacitance to any ac ground for all of the signal I/O pins. Parasitic capacitance on the output and input pins can cause instability. To reduce unwanted capacitance, a window around the signal I/O pins should be opened in all of the ground and power planes around those pins. Otherwise, ground and power planes should be unbroken elsewhere on the board.
- Minimize the distance ( $< 0.25''$ , 6.35 mm) from the power-supply pins to high frequency 0.1- $\mu\text{F}$  decoupling capacitors. At the device pins, the ground and power-plane layout should not be in close proximity to the signal I/O pins. Avoid narrow power and ground traces to minimize inductance between the pins and the decoupling capacitors. The power supply connections should always be decoupled with these capacitors. Larger (6.8  $\mu\text{F}$  or more) tantalum decoupling capacitors, effective at lower frequency, should also be used on the main supply pins. These may be placed somewhat farther from the device and may be shared among several devices in the same area of the PCB. The primary goal is to minimize the impedance seen in the differential-current return paths.
- Careful selection and placement of external components preserve the high-frequency performance of the THS4500 family. Resistors should be a very low reactance type. Surface-mount resistors work best and allow a tighter overall layout. Metal-film and carbon composition, axially-leaded resistors can also provide good high frequency performance. Again, keep the leads and PCB trace length as short as possible. Never use wirewound type resistors in a high-frequency application. Since the output pin and inverting input pins are the most sensitive to parasitic capacitance, always position the feedback and series output resistors, if any, as close as possible to the inverting input pins and output pins. Other network components, such as input termination resistors, should be placed close to the gain-setting resistors. Even with a low parasitic capacitance shunting the external resistors, excessively high resistor values can create significant time constants that can degrade performance. Good axial metal-film or surface-mount resistors have approximately 0.2 pF in shunt with the resistor. For resistor values greater than 2.0 k $\Omega$ , this parasitic capacitance can add a pole and/or a zero below 400 MHz that can affect circuit operation. Keep resistor values as low as possible, consistent with load driving considerations.
- Connections to other wideband devices on the board may be made with short direct traces or through onboard transmission lines. For short connections, consider the trace and the input to the next device as a lumped capacitive load. Relatively wide traces (50 mils to 100 mils, or 1.27 mm to 2.54 mm) should be used, preferably with ground and power planes opened up around them. Estimate the total capacitive load and determine if isolation resistors on the outputs are necessary. Low parasitic capacitive loads (less than 4 pF) may not need an  $R_S$  since the THS4500 family is nominally compensated to operate with a 2-pF parasitic load. Higher parasitic capacitive loads without an  $R_S$  are allowed as the signal gain increases (increasing the unloaded phase margin). If a long trace is required, and the 6-dB signal loss intrinsic to a doubly-terminated transmission line is acceptable, implement a matched impedance transmission line using microstrip or stripline techniques (consult an ECL design handbook for microstrip and stripline layout techniques).
- A 50- $\Omega$  environment is normally not necessary onboard, and in fact, a higher impedance environment improves distortion as shown in the distortion versus load plots. With a characteristic board trace impedance defined based onboard material and trace dimensions, a matching series resistor into the trace from the output of the THS4500 family is used as well as a terminating shunt resistor at the input of the destination device.
- Remember also that the terminating impedance is the parallel combination of the shunt resistor and the input impedance of the destination device: this total effective impedance should be set to match the trace impedance. If the 6-dB attenuation of a doubly-terminated transmission line is unacceptable, a long trace can be series-terminated at the source end only. Treat the trace as a capacitive load in this case. This configuration does not preserve signal integrity as well as a doubly-terminated line. If the input impedance of the destination device is low, there is some signal attenuation due to the voltage divider formed by the series output into the terminating impedance.
- Socketing a high-speed part such as the THS4500 family is not recommended. The additional lead length and pin-to-pin capacitance introduced by the socket can create an extremely troublesome parasitic network that can make it almost

impossible to achieve a smooth, stable frequency response. Best results are obtained by soldering the THS4500 family parts directly onto the board.

**PowerPAD DESIGN CONSIDERATIONS**

The THS4500 family is available in a thermally-enhanced PowerPAD set of packages. These packages are constructed using a downset leadframe upon which the die is mounted [see Figure 111(a) and Figure 111(b)]. This arrangement results in the lead frame being exposed as a thermal pad on the underside of the package [see Figure 111(c)]. Because this thermal pad has direct thermal contact with the die, excellent thermal performance can be achieved by providing a good thermal path away from the thermal pad.

The PowerPAD package allows for both assembly and thermal management in one manufacturing operation. During the surface-mount solder operation (when the leads are being soldered), the thermal pad can also be soldered to a copper area underneath the package. Through the use of thermal paths within this copper area, heat can be conducted away from the package into either a ground plane or other heat dissipating device.

The PowerPAD package represents a breakthrough in combining the small area and ease of assembly of surface mount with the, heretofore, awkward mechanical methods of heatsinking.

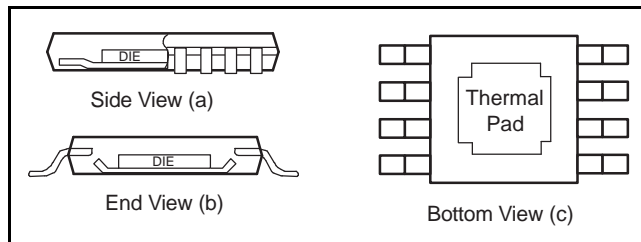

**Figure 111. Views of PowerPAD, Thermally-Enhanced Package**

Although there are many ways to properly heatsink the PowerPAD package, the following steps illustrate the recommended approach.

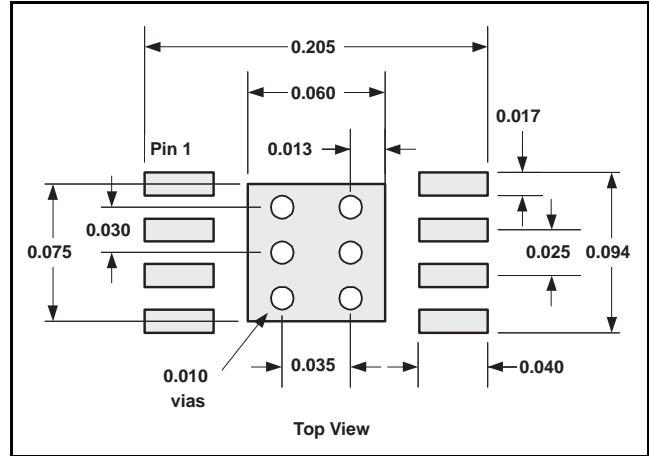

**Figure 112. PowerPAD PCB Etch and Via Pattern**

**PowerPAD PCB LAYOUT CONSIDERATIONS**

1. Prepare the PCB with a top side etch pattern as shown in Figure 112. There should be etch for the leads as well as etch for the thermal pad.
2. Place five holes in the area of the thermal pad. These holes should be 13 mils (0.33 mm) in diameter. Keep them small so that solder wicking through the holes is not a problem during reflow.
3. Additional vias may be placed anywhere along the thermal plane outside of the thermal pad area. These holes help dissipate the heat generated by the THS4500 family IC. These additional vias may be larger than the 13-mil diameter vias directly under the thermal pad. They can be larger because they are not in the thermal pad area to be soldered so that wicking is not a problem.
4. Connect all holes to the internal ground plane.
5. When connecting these holes to the ground plane, **do not** use the typical web or spoke via connection methodology. Web connections have a high thermal resistance connection that is useful for slowing the heat transfer during soldering operations. This transfer slowing makes the soldering of vias that have plane connections easier. In this application, however, low thermal resistance is desired for the most efficient heat transfer. Therefore, the holes under the THS4500 family PowerPAD package should make their connection to the internal ground plane with a complete connection around the entire circumference of the plated-through hole.



6. The top-side solder mask should leave the terminals of the package and the thermal pad area with its five holes exposed. The bottom-side solder mask should cover the five holes of the thermal pad area. This configuration prevents solder from being pulled away from the thermal pad area during the reflow process.
7. Apply solder paste to the exposed thermal pad area and all of the IC terminals.
8. With these preparatory steps in place, the IC is simply placed in position and run through the solder reflow operation as any standard surface-mount component. This process results in a part that is properly installed.

## POWER DISSIPATION AND THERMAL CONSIDERATIONS

The THS4500 family of devices does not incorporate automatic thermal shutoff protection, so the designer must take care to ensure that the design does not violate the absolute maximum junction temperature of the device. Failure may result if the absolute maximum junction temperature of +150°C is exceeded. For best performance, design for a maximum junction temperature of +125°C. Between +125°C and +150°C, damage does not occur, but the performance of the amplifier begins to degrade.

The thermal characteristics of the device are dictated by the package and the PCB. Maximum power dissipation for a given package can be calculated using the following formula.

$$P_{Dmax} = \frac{T_{MAX} - T_A}{\theta_{JA}} \quad (28)$$

Where:

$P_{Dmax}$  is the maximum power dissipation in the amplifier (W).

$T_{MAX}$  is the absolute maximum junction temperature (°C).

$T_A$  is the ambient temperature (°C).

$$\theta_{JA} = \theta_{JC} + \theta_{CA}$$

$\theta_{JC}$  is the thermal coefficient from the silicon junctions to the case (°C/W).

$\theta_{CA}$  is the thermal coefficient from the case to ambient air (°C/W).

For systems where heat dissipation is more critical, the THS4500 family of devices is offered in an MSOP-8 package with PowerPAD. The thermal coefficient for the MSOP PowerPAD package is substantially improved over the traditional SOIC. Maximum power dissipation levels are depicted in

Figure 113 for the two packages. The data for the DGN package assumes a board layout that follows the PowerPAD layout guidelines referenced above and detailed in the PowerPAD application notes in the *Additional Reference Material* section at the end of the data sheet.

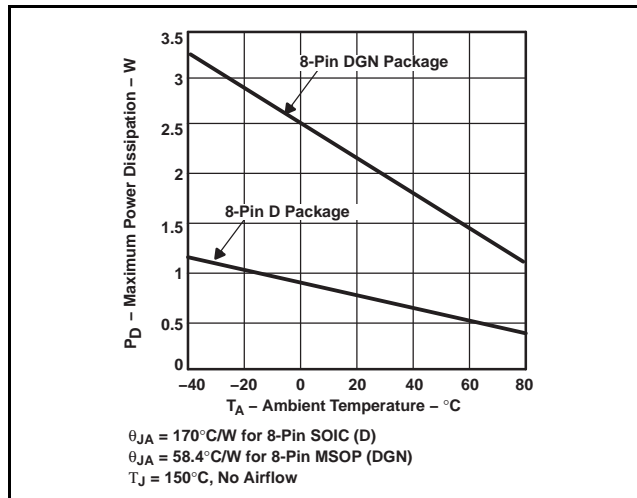

Figure 113. Maximum Power Dissipation vs Ambient Temperature

When determining whether or not the device satisfies the maximum power dissipation requirement, it is important to not only consider quiescent power dissipation, but also dynamic power dissipation. Often times, this consideration is difficult to quantify because the signal pattern is inconsistent; an estimate of the RMS power dissipation can provide visibility into a possible problem.

## DRIVING CAPACITIVE LOADS

High-speed amplifiers are typically not well-suited for driving large capacitive loads. If necessary, however, the load capacitance should be isolated by two isolation resistors in series with the output. The requisite isolation resistor size depends on the value of the capacitance, but 10 Ω to 25 Ω is a good place to begin the optimization process. Larger isolation resistors decrease the amount of peaking in the frequency response induced by the capacitive load, but this decreased peaking comes at the expense of a larger voltage drop across the resistors, increasing the output swing requirements of the system.

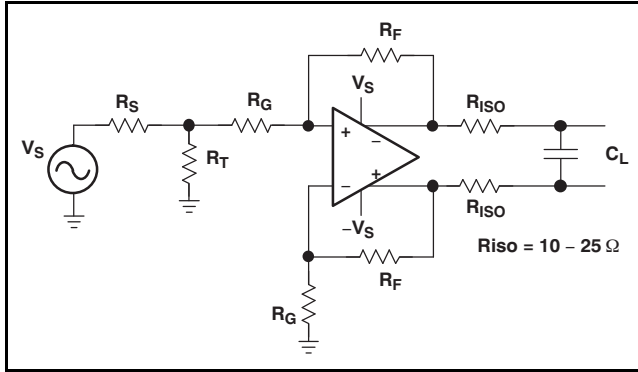

Figure 114. Use of Isolation Resistors With a Capacitive Load

### POWER-SUPPLY DECOUPLING TECHNIQUES AND RECOMMENDATIONS

Power-supply decoupling is a critical aspect of any high-performance amplifier design process. Careful decoupling provides higher quality ac performance (most notably improved distortion performance). The following guidelines ensure the highest level of performance.

1. Place decoupling capacitors as close to the power-supply inputs as possible, with the goal of minimizing the inductance of the path from ground to the power supply.
2. Placement priority should be as follows: smaller capacitors should be closer to the device.
3. Use of solid power and ground planes is recommended to reduce the inductance along power-supply return current paths.
4. Recommended values for power-supply decoupling include 10- $\mu$ F and 0.1- $\mu$ F capacitors for each supply. A 1000-pF capacitor can be used across the supplies as well for extremely high frequency return currents, but often is not required.

### EVALUATION FIXTURES, SPICE MODELS, AND APPLICATIONS SUPPORT

Texas Instruments is committed to providing its customers with the highest quality of applications support. To support this goal, an evaluation board has been developed for the THS4500 family of fully differential amplifiers. The evaluation board can be obtained by ordering through the [THS4500](#) or

THS4501 product folder on the Texas Instruments web site, [www.ti.com](http://www.ti.com), or through your local Texas Instruments sales representative. A schematic for the evaluation board is shown in Figure 115 with the default component values. Unpopulated footprints are shown to provide insight into design flexibility.

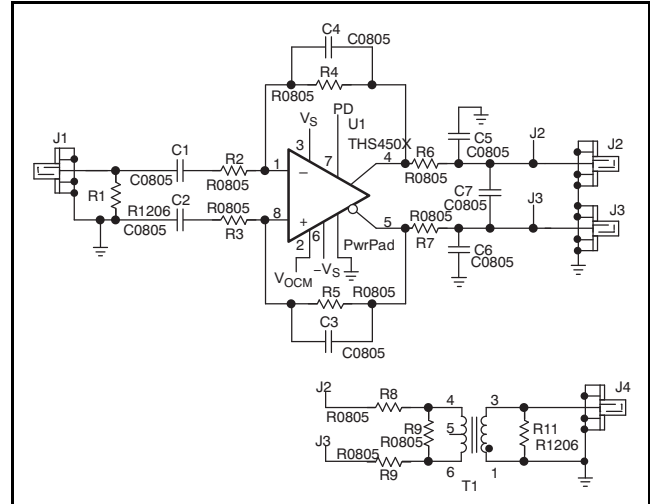

Figure 115. Simplified Schematic of the Evaluation Board

Computer simulation of circuit performance using SPICE is often useful when analyzing the performance of analog circuits and systems. This practice is particularly true for video and RF amplifier circuits where parasitic capacitance and inductance can have a major effect on circuit performance. A SPICE model for the THS4500 family of devices is available through either the Texas Instruments web site ([www.ti.com](http://www.ti.com)) or as one model on a disk from the Texas Instruments Product Information Center (1-800-548-6132). The PIC is also available for design assistance and detailed product information at this number. These models do a good job of predicting small-signal ac and transient performance under a wide variety of operating conditions. They are not intended to model the distortion characteristics of the amplifier, nor do they attempt to distinguish between the package types in their small-signal ac performance. Detailed information about what is and is not modeled is contained in the model file itself.

## ADDITIONAL REFERENCE MATERIAL

- *PowerPAD Made Easy*, application brief, Texas Instruments Literature Number [SLMA004](#).
- *PowerPAD Thermally-Enhanced Package*, technical brief, Texas Instruments Literature Number [SLMA002](#).
- Karki, James. *Fully Differential Amplifiers*. application report, Texas Instruments Literature Number [SLOA054D](#).
- Karki, James. *Fully Differential Amplifiers Applications: Line Termination, Driving High-Speed ADCs, and Differential Transmission Lines*. Texas Instruments Analog Applications Journal, February 2001.
- Carter, Bruce. *A Differential Op-Amp Circuit Collection*. application report, Texas Instruments Literature Number [SLOA064](#).
- Carter, Bruce. *Differential Op-Amp Single-Supply Design Technique*, application report, Texas Instruments Literature Number [SLOA072](#).
- Karki, James. *Designing for Low Distortion with High-Speed Op Amps*. Texas Instruments Analog Applications Journal, July 2001.

## Revision History

Changes from Revision D (January 2004) to Revision E	Page
• Updated document format .....	1
• Clarified cross-references throughout the document.....	1
• Added footnote 1 to <a href="#">Package/Ordering Information</a> table .....	3
• Changed x-axis of <a href="#">Figure 27</a> .....	12
• Updated crossreferences for <a href="#">Figure 97</a> in first two paragraphs of the <a href="#">Fully Differential Amplifier Terminal Functions</a> section.....	22
• Added <i>available for download at <a href="http://www.ti.com">www.ti.com</a></i> and end of second paragraph of the <a href="#">Fully Differential Amplifier Terminal Functions</a> section.....	22
• Changed <i>allow for calculation of to are used to calculate</i> in second paragraph of <a href="#">Input Common-Mode Voltage Range and the THS4500 Family</a> section .....	22
• Clarified last sentence of third paragraph of <a href="#">Input Common-Mode Voltage Range and the THS4500 Family</a> section .....	22
• Changed <i>two</i> to <i>four</i> in first sentence of <a href="#">Input Common-Mode Voltage Range and the THS4500 Family</a> section .....	22
• Corrected title of <a href="#">Basic Design Considerations</a> section.....	24
• Clarified cross-references of the circuits mentioned in the first sentence of the <a href="#">Basic Design Considerations</a> section .....	24
• Deleted figure from <a href="#">Basic Design Considerations</a> section.....	24
• Corrected cross-references in first sentence of <a href="#">Basic Design Considerations</a> section .....	24
• Clarified the <a href="#">Interfacing to an Analog-to-Digital Converter</a> section.....	25
• Removed cross-reference to nonexistent table in second paragraph of <a href="#">Setting the Output Common-Mode Voltage with the <math>V_{OCM}</math> Input</a> section.....	27
• Added caption titles to figures in the <a href="#">Linearity: Definitions, Terminology, Circuit Techniques, and Design Tradeoffs</a> section.....	28
• Changed <i>THS4502</i> to <i>THS4500</i> in seventh paragraph of <a href="#">Linearity: Definitions, Terminology, Circuit Techniques, and Design Tradeoffs</a> section .....	28
• Corrected spelling in title of <a href="#">An Analysis of Noise in Fully Differential Amplifiers</a> section.....	29
• Added <i>6.35 mm</i> to second bullet of <a href="#">Printed Circuit Board Layout Techniques for Optimal Performance</a> list .....	31
• Added <i>1.27 mm to 2.54 mm</i> to fourth bullet of <a href="#">Printed Circuit Board Layout Techniques for Optimal Performance</a> list .....	31
• Added <i>0.33 mm</i> to second list item in the <a href="#">PowerPAD PCB Layout Considerations</a> section.....	32
• Changed title of <a href="#">Figure 115</a> .....	34

**PACKAGING INFORMATION**

Orderable Device	Status <sup>(1)</sup>	Package Type	Package Drawing	Pins	Package Qty	Eco Plan <sup>(2)</sup>	Lead/Ball Finish	MSL Peak Temp <sup>(3)</sup>
THS4500CD	ACTIVE	SOIC	D	8	75	Green (RoHS & no Sb/Br)	CU NIPDAU	Level-1-260C-UNLIM
THS4500CDG4	ACTIVE	SOIC	D	8	75	Green (RoHS & no Sb/Br)	CU NIPDAU	Level-1-260C-UNLIM
THS4500CDGK	ACTIVE	MSOP	DGK	8	80	Green (RoHS & no Sb/Br)	CU NIPDAU	Level-1-260C-UNLIM
THS4500CDGKG4	ACTIVE	MSOP	DGK	8	80	Green (RoHS & no Sb/Br)	CU NIPDAU	Level-1-260C-UNLIM
THS4500CDGKR	ACTIVE	MSOP	DGK	8	2500	Green (RoHS & no Sb/Br)	CU NIPDAU	Level-1-260C-UNLIM
THS4500CDGKRG4	ACTIVE	MSOP	DGK	8	2500	Green (RoHS & no Sb/Br)	CU NIPDAU	Level-1-260C-UNLIM
THS4500CDGN	ACTIVE	MSOP-Power PAD	DGN	8	80	Green (RoHS & no Sb/Br)	CU NIPDAU	Level-1-260C-UNLIM
THS4500CDGNG4	ACTIVE	MSOP-Power PAD	DGN	8	80	Green (RoHS & no Sb/Br)	CU NIPDAU	Level-1-260C-UNLIM
THS4500CDGNR	ACTIVE	MSOP-Power PAD	DGN	8	2500	Green (RoHS & no Sb/Br)	CU NIPDAU	Level-1-260C-UNLIM
THS4500CDGNRG4	ACTIVE	MSOP-Power PAD	DGN	8	2500	Green (RoHS & no Sb/Br)	CU NIPDAU	Level-1-260C-UNLIM
THS4500CDR	ACTIVE	SOIC	D	8	2500	Green (RoHS & no Sb/Br)	CU NIPDAU	Level-1-260C-UNLIM
THS4500CDRG4	ACTIVE	SOIC	D	8	2500	Green (RoHS & no Sb/Br)	CU NIPDAU	Level-1-260C-UNLIM
THS4500ID	ACTIVE	SOIC	D	8	75	Green (RoHS & no Sb/Br)	CU NIPDAU	Level-1-260C-UNLIM
THS4500IDG4	ACTIVE	SOIC	D	8	75	Green (RoHS & no Sb/Br)	CU NIPDAU	Level-1-260C-UNLIM
THS4500IDGK	ACTIVE	MSOP	DGK	8	80	Green (RoHS & no Sb/Br)	CU NIPDAU	Level-1-260C-UNLIM
THS4500IDGKG4	ACTIVE	MSOP	DGK	8	80	Green (RoHS & no Sb/Br)	CU NIPDAU	Level-1-260C-UNLIM
THS4500IDGKR	ACTIVE	MSOP	DGK	8	2500	Green (RoHS & no Sb/Br)	CU NIPDAU	Level-1-260C-UNLIM
THS4500IDGKRG4	ACTIVE	MSOP	DGK	8	2500	Green (RoHS & no Sb/Br)	CU NIPDAU	Level-1-260C-UNLIM
THS4500IDGN	ACTIVE	MSOP-Power PAD	DGN	8	80	Green (RoHS & no Sb/Br)	CU NIPDAU	Level-1-260C-UNLIM
THS4500IDGNG4	ACTIVE	MSOP-Power PAD	DGN	8	80	Green (RoHS & no Sb/Br)	CU NIPDAU	Level-1-260C-UNLIM
THS4500IDGNR	ACTIVE	MSOP-Power PAD	DGN	8	2500	Green (RoHS & no Sb/Br)	CU NIPDAU	Level-1-260C-UNLIM
THS4500IDGNRG4	ACTIVE	MSOP-Power	DGN	8	2500	Green (RoHS & no Sb/Br)	CU NIPDAU	Level-1-260C-UNLIM

Orderable Device	Status <sup>(1)</sup>	Package Type	Package Drawing	Pins	Package Qty	Eco Plan <sup>(2)</sup>	Lead/Ball Finish	MSL Peak Temp <sup>(3)</sup>
		PAD						
THS4500IDR	ACTIVE	SOIC	D	8	2500	Green (RoHS & no Sb/Br)	CU NIPDAU	Level-1-260C-UNLIM
THS4500IDRG4	ACTIVE	SOIC	D	8	2500	Green (RoHS & no Sb/Br)	CU NIPDAU	Level-1-260C-UNLIM
THS4501CD	ACTIVE	SOIC	D	8	75	Green (RoHS & no Sb/Br)	CU NIPDAU	Level-1-260C-UNLIM
THS4501CDG4	ACTIVE	SOIC	D	8	75	Green (RoHS & no Sb/Br)	CU NIPDAU	Level-1-260C-UNLIM
THS4501CDGK	ACTIVE	MSOP	DGK	8	80	Green (RoHS & no Sb/Br)	CU NIPDAU	Level-1-260C-UNLIM
THS4501CDGKG4	ACTIVE	MSOP	DGK	8	80	Green (RoHS & no Sb/Br)	CU NIPDAU	Level-1-260C-UNLIM
THS4501CDGKR	ACTIVE	MSOP	DGK	8	2500	Green (RoHS & no Sb/Br)	CU NIPDAU	Level-1-260C-UNLIM
THS4501CDGKRG4	ACTIVE	MSOP	DGK	8	2500	Green (RoHS & no Sb/Br)	CU NIPDAU	Level-1-260C-UNLIM
THS4501CDGN	ACTIVE	MSOP-Power PAD	DGN	8	80	Green (RoHS & no Sb/Br)	CU NIPDAU	Level-1-260C-UNLIM
THS4501CDGNG4	ACTIVE	MSOP-Power PAD	DGN	8	80	Green (RoHS & no Sb/Br)	CU NIPDAU	Level-1-260C-UNLIM
THS4501CDGNR	ACTIVE	MSOP-Power PAD	DGN	8	2500	Green (RoHS & no Sb/Br)	CU NIPDAU	Level-1-260C-UNLIM
THS4501CDGNRG4	ACTIVE	MSOP-Power PAD	DGN	8	2500	Green (RoHS & no Sb/Br)	CU NIPDAU	Level-1-260C-UNLIM
THS4501CDR	ACTIVE	SOIC	D	8	2500	Green (RoHS & no Sb/Br)	CU NIPDAU	Level-1-260C-UNLIM
THS4501CDRG4	ACTIVE	SOIC	D	8	2500	Green (RoHS & no Sb/Br)	CU NIPDAU	Level-1-260C-UNLIM
THS4501ID	ACTIVE	SOIC	D	8	75	Green (RoHS & no Sb/Br)	CU NIPDAU	Level-1-260C-UNLIM
THS4501IDG4	ACTIVE	SOIC	D	8	75	Green (RoHS & no Sb/Br)	CU NIPDAU	Level-1-260C-UNLIM
THS4501IDGK	ACTIVE	MSOP	DGK	8	80	Green (RoHS & no Sb/Br)	CU NIPDAU	Level-1-260C-UNLIM
THS4501IDGKG4	ACTIVE	MSOP	DGK	8	80	Green (RoHS & no Sb/Br)	CU NIPDAU	Level-1-260C-UNLIM
THS4501IDGKR	ACTIVE	MSOP	DGK	8	2500	Green (RoHS & no Sb/Br)	CU NIPDAU	Level-1-260C-UNLIM
THS4501IDGKRG4	ACTIVE	MSOP	DGK	8	2500	Green (RoHS & no Sb/Br)	CU NIPDAU	Level-1-260C-UNLIM
THS4501IDGN	ACTIVE	MSOP-Power PAD	DGN	8	80	Green (RoHS & no Sb/Br)	CU NIPDAU	Level-1-260C-UNLIM
THS4501IDGNG4	ACTIVE	MSOP-Power PAD	DGN	8	80	Green (RoHS & no Sb/Br)	CU NIPDAU	Level-1-260C-UNLIM
THS4501IDGNR	ACTIVE	MSOP-	DGN	8	2500	Green (RoHS & no Sb/Br)	CU NIPDAU	Level-1-260C-UNLIM

Orderable Device	Status <sup>(1)</sup>	Package Type	Package Drawing	Pins	Package Qty	Eco Plan <sup>(2)</sup>	Lead/Ball Finish	MSL Peak Temp <sup>(3)</sup>
		Power PAD				no Sb/Br)		
THS4501IDGNRG4	ACTIVE	MSOP-Power PAD	DGN	8	2500	Green (RoHS & no Sb/Br)	CU NIPDAU	Level-1-260C-UNLIM
THS4501IDR	ACTIVE	SOIC	D	8	2500	Green (RoHS & no Sb/Br)	CU NIPDAU	Level-1-260C-UNLIM
THS4501IDRG4	ACTIVE	SOIC	D	8	2500	Green (RoHS & no Sb/Br)	CU NIPDAU	Level-1-260C-UNLIM

<sup>(1)</sup> The marketing status values are defined as follows:

**ACTIVE:** Product device recommended for new designs.

**LIFEBUY:** TI has announced that the device will be discontinued, and a lifetime-buy period is in effect.

**NRND:** Not recommended for new designs. Device is in production to support existing customers, but TI does not recommend using this part in a new design.

**PREVIEW:** Device has been announced but is not in production. Samples may or may not be available.

**OBSOLETE:** TI has discontinued the production of the device.

<sup>(2)</sup> Eco Plan - The planned eco-friendly classification: Pb-Free (RoHS), Pb-Free (RoHS Exempt), or Green (RoHS & no Sb/Br) - please check <http://www.ti.com/productcontent> for the latest availability information and additional product content details.

**TBD:** The Pb-Free/Green conversion plan has not been defined.

**Pb-Free (RoHS):** TI's terms "Lead-Free" or "Pb-Free" mean semiconductor products that are compatible with the current RoHS requirements for all 6 substances, including the requirement that lead not exceed 0.1% by weight in homogeneous materials. Where designed to be soldered at high temperatures, TI Pb-Free products are suitable for use in specified lead-free processes.

**Pb-Free (RoHS Exempt):** This component has a RoHS exemption for either 1) lead-based flip-chip solder bumps used between the die and package, or 2) lead-based die adhesive used between the die and leadframe. The component is otherwise considered Pb-Free (RoHS compatible) as defined above.

**Green (RoHS & no Sb/Br):** TI defines "Green" to mean Pb-Free (RoHS compatible), and free of Bromine (Br) and Antimony (Sb) based flame retardants (Br or Sb do not exceed 0.1% by weight in homogeneous material)

<sup>(3)</sup> MSL, Peak Temp. -- The Moisture Sensitivity Level rating according to the JEDEC industry standard classifications, and peak solder temperature.

**Important Information and Disclaimer:**The information provided on this page represents TI's knowledge and belief as of the date that it is provided. TI bases its knowledge and belief on information provided by third parties, and makes no representation or warranty as to the accuracy of such information. Efforts are underway to better integrate information from third parties. TI has taken and continues to take reasonable steps to provide representative and accurate information but may not have conducted destructive testing or chemical analysis on incoming materials and chemicals. TI and TI suppliers consider certain information to be proprietary, and thus CAS numbers and other limited information may not be available for release.

In no event shall TI's liability arising out of such information exceed the total purchase price of the TI part(s) at issue in this document sold by TI to Customer on an annual basis.

**TAPE AND REEL INFORMATION**



**QUADRANT ASSIGNMENTS FOR PIN 1 ORIENTATION IN TAPE**



\*All dimensions are nominal

Device	Package Type	Package Drawing	Pins	SPQ	Reel Diameter (mm)	Reel Width W1 (mm)	A0 (mm)	B0 (mm)	K0 (mm)	P1 (mm)	W (mm)	Pin1 Quadrant
THS4500CDGKR	MSOP	DGK	8	2500	330.0	12.4	5.2	3.3	1.6	8.0	12.0	Q1
THS4500CDGNR	MSOP-Power PAD	DGN	8	2500	330.0	12.4	5.2	3.3	1.6	8.0	12.0	Q1
THS4500CDR	SOIC	D	8	2500	330.0	12.4	6.4	5.2	2.1	8.0	12.0	Q1
THS4500IDGKR	MSOP	DGK	8	2500	330.0	12.4	5.2	3.3	1.6	8.0	12.0	Q1
THS4500IDGNR	MSOP-Power PAD	DGN	8	2500	330.0	12.4	5.2	3.3	1.6	8.0	12.0	Q1
THS4500IDR	SOIC	D	8	2500	330.0	12.4	6.4	5.2	2.1	8.0	12.0	Q1
THS4501CDGKR	MSOP	DGK	8	2500	330.0	12.4	5.2	3.3	1.6	8.0	12.0	Q1
THS4501CDGNR	MSOP-Power PAD	DGN	8	2500	330.0	12.4	5.2	3.3	1.6	8.0	12.0	Q1
THS4501CDR	SOIC	D	8	2500	330.0	12.4	6.4	5.2	2.1	8.0	12.0	Q1
THS4501IDGKR	MSOP	DGK	8	2500	330.0	12.4	5.2	3.3	1.6	8.0	12.0	Q1
THS4501IDGNR	MSOP-Power PAD	DGN	8	2500	330.0	12.4	5.2	3.3	1.6	8.0	12.0	Q1
THS4501IDR	SOIC	D	8	2500	330.0	12.4	6.4	5.2	2.1	8.0	12.0	Q1

**TAPE AND REEL BOX DIMENSIONS**

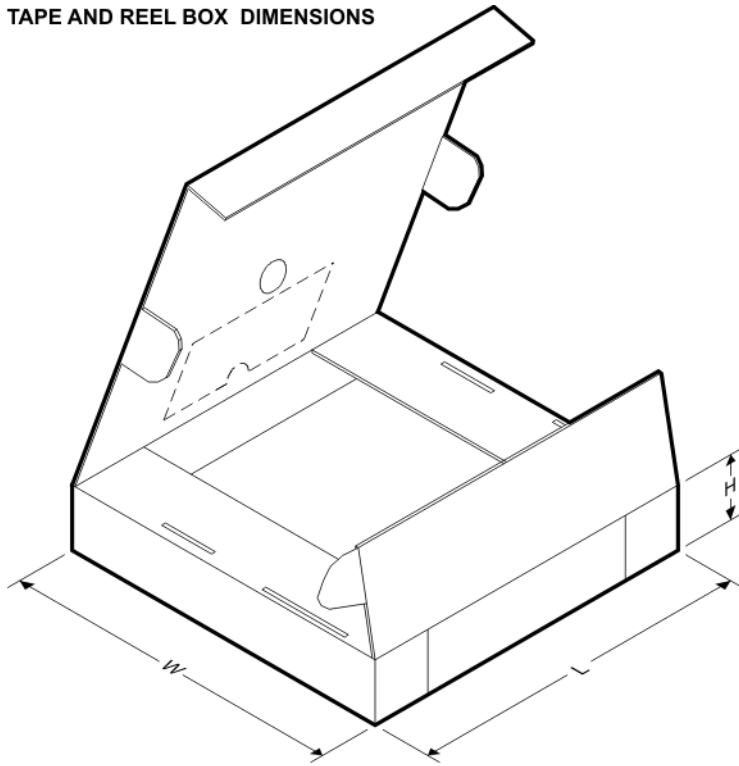

\*All dimensions are nominal

Device	Package Type	Package Drawing	Pins	SPQ	Length (mm)	Width (mm)	Height (mm)
THS4500CDGKR	MSOP	DGK	8	2500	338.1	340.5	21.1
THS4500CDGNR	MSOP-PowerPAD	DGN	8	2500	338.1	340.5	21.1
THS4500CDR	SOIC	D	8	2500	346.0	346.0	29.0
THS4500IDGKR	MSOP	DGK	8	2500	338.1	340.5	21.1
THS4500IDGNR	MSOP-PowerPAD	DGN	8	2500	338.1	340.5	21.1
THS4500IDR	SOIC	D	8	2500	346.0	346.0	29.0
THS4501CDGKR	MSOP	DGK	8	2500	338.1	340.5	21.1
THS4501CDGNR	MSOP-PowerPAD	DGN	8	2500	338.1	340.5	21.1
THS4501CDR	SOIC	D	8	2500	346.0	346.0	29.0
THS4501IDGKR	MSOP	DGK	8	2500	338.1	340.5	21.1
THS4501IDGNR	MSOP-PowerPAD	DGN	8	2500	338.1	340.5	21.1
THS4501IDR	SOIC	D	8	2500	346.0	346.0	29.0



# MECHANICAL DATA

DGN (S-PDSO-G8)

PowerPAD™ PLASTIC SMALL-OUTLINE PACKAGE

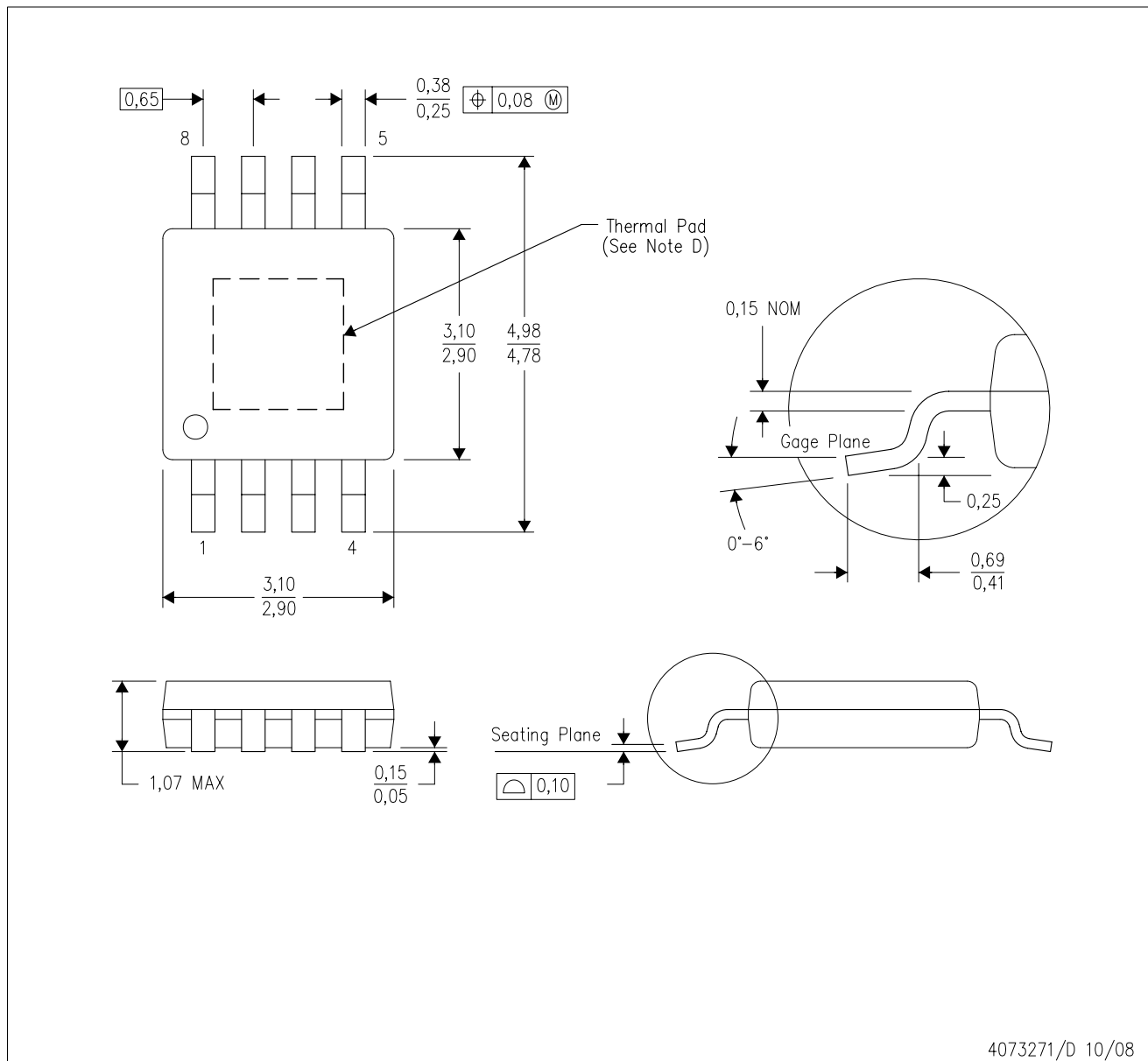

- NOTES:
- All linear dimensions are in millimeters.
  - This drawing is subject to change without notice.
  - Body dimensions do not include mold flash or protrusion.
  - This package is designed to be soldered to a thermal pad on the board. Refer to Technical Brief, PowerPad Thermally Enhanced Package, Texas Instruments Literature No. SLMA002 for information regarding recommended board layout. This document is available at [www.ti.com](http://www.ti.com) <<http://www.ti.com>>.
  - Falls within JEDEC MO-187

PowerPAD is a trademark of Texas Instruments.

THERMAL INFORMATION

This PowerPAD™ package incorporates an exposed thermal pad that is designed to be attached directly to an external heatsink. The thermal pad must be soldered directly to the printed circuit board (PCB). After soldering, the PCB can be used as a heatsink. In addition, through the use of thermal vias, the thermal pad can be attached directly to the appropriate copper plane shown in the electrical schematic for the device, or alternatively, can be attached to a special heatsink structure designed into the PCB. This design optimizes the heat transfer from the integrated circuit (IC).

For additional information on the PowerPAD package and how to take advantage of its heat dissipating abilities, refer to Technical Brief, PowerPAD Thermally Enhanced Package, Texas Instruments Literature No. SLMA002 and Application Brief, PowerPAD Made Easy, Texas Instruments Literature No. SLMA004. Both documents are available at [www.ti.com](http://www.ti.com).

The exposed thermal pad dimensions for this package are shown in the following illustration.

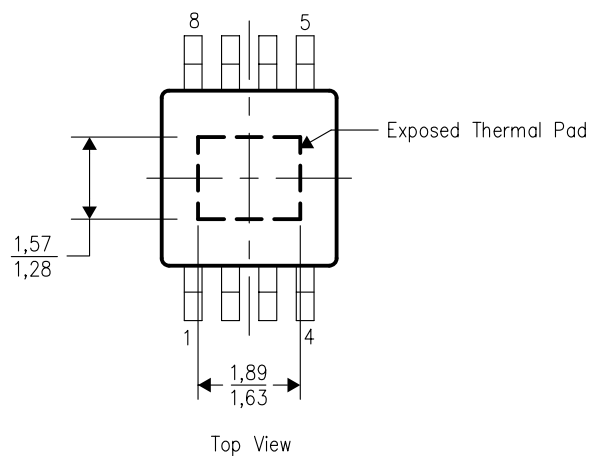

NOTE: All linear dimensions are in millimeters

Exposed Thermal Pad Dimensions

DGN (R-PDS0-G8) PowerPAD™

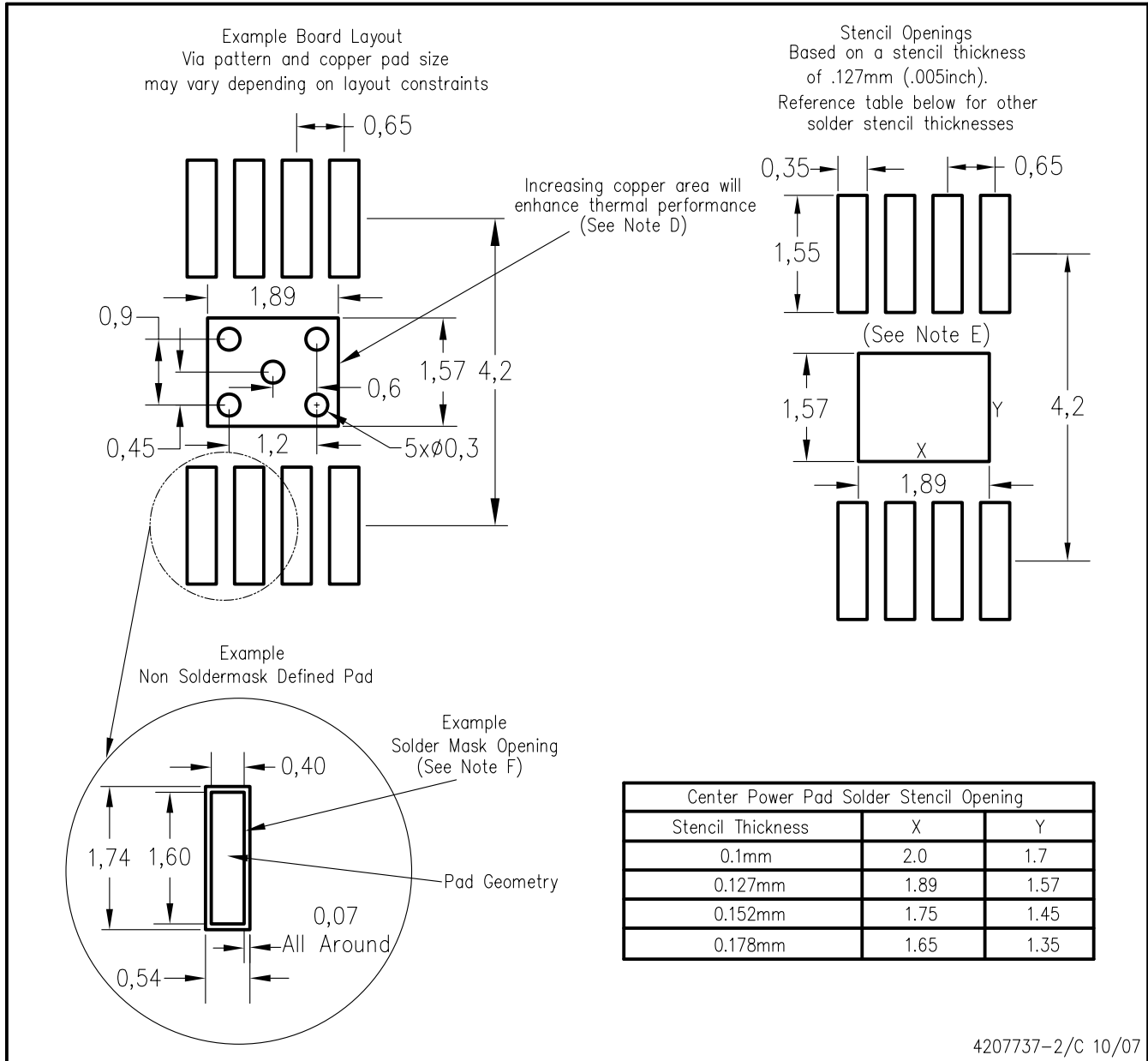

4207737-2/C 10/07

- NOTES:
- A. All linear dimensions are in millimeters.
  - B. This drawing is subject to change without notice.
  - C. Customers should place a note on the circuit board fabrication drawing not to alter the center solder mask defined pad.
  - D. This package is designed to be soldered to a thermal pad on the board. Refer to Technical Brief, PowerPad Thermally Enhanced Package, Texas Instruments Literature No. SLMA002, SLMA004, and also the Product Data Sheets for specific thermal information, via requirements, and recommended board layout. These documents are available at [www.ti.com](http://www.ti.com) <<http://www.ti.com>>. Publication IPC-7351 is recommended for alternate designs.
  - E. Laser cutting apertures with trapezoidal walls and also rounding corners will offer better paste release. Customers should contact their board assembly site for stencil design recommendations. Example stencil design based on a 50% volumetric metal load solder paste. Refer to IPC-7525 for other stencil recommendations.
  - F. Customers should contact their board fabrication site for solder mask tolerances between and around signal pads.

DGK (S-PDSO-G8)

PLASTIC SMALL-OUTLINE PACKAGE



4073329/E 05/06

- NOTES:
- A. All linear dimensions are in millimeters.
  - B. This drawing is subject to change without notice.
  - C. Body length does not include mold flash, protrusions, or gate burrs. Mold flash, protrusions, or gate burrs shall not exceed 0.15 per end.
  - D. Body width does not include interlead flash. Interlead flash shall not exceed 0.50 per side.
  - E. Falls within JEDEC MO-187 variation AA, except interlead flash.

D (R-PDSO-G8)

PLASTIC SMALL-OUTLINE PACKAGE

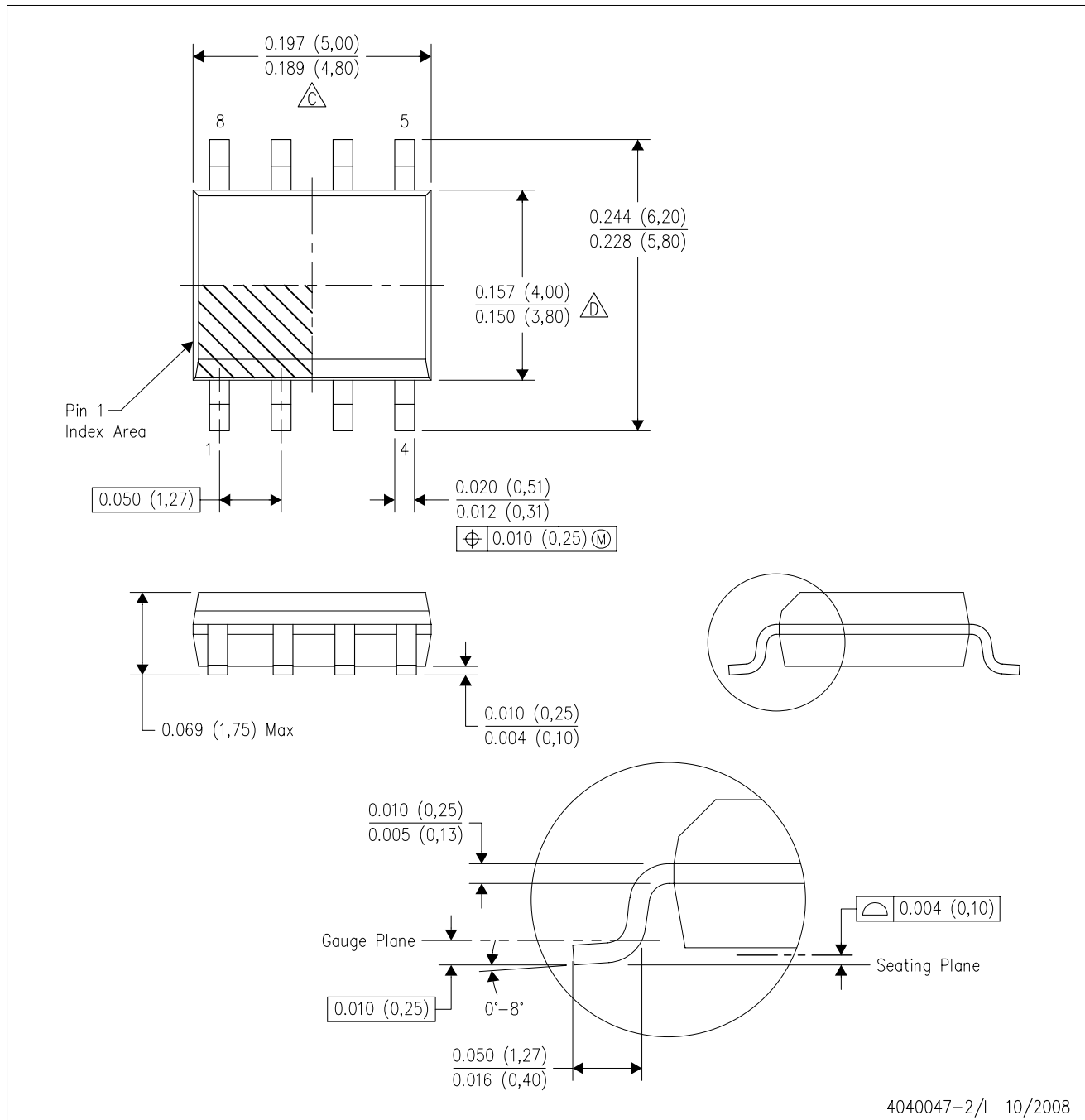

- NOTES:
- A. All linear dimensions are in inches (millimeters).
  - B. This drawing is subject to change without notice.
  - C. Body length does not include mold flash, protrusions, or gate burrs. Mold flash, protrusions, or gate burrs shall not exceed .006 (0,15) per end.
  - D. Body width does not include interlead flash. Interlead flash shall not exceed .017 (0,43) per side.
  - E. Reference JEDEC MS-012 variation AA.

## IMPORTANT NOTICE

Texas Instruments Incorporated and its subsidiaries (TI) reserve the right to make corrections, modifications, enhancements, improvements, and other changes to its products and services at any time and to discontinue any product or service without notice. Customers should obtain the latest relevant information before placing orders and should verify that such information is current and complete. All products are sold subject to TI's terms and conditions of sale supplied at the time of order acknowledgment.

TI warrants performance of its hardware products to the specifications applicable at the time of sale in accordance with TI's standard warranty. Testing and other quality control techniques are used to the extent TI deems necessary to support this warranty. Except where mandated by government requirements, testing of all parameters of each product is not necessarily performed.

TI assumes no liability for applications assistance or customer product design. Customers are responsible for their products and applications using TI components. To minimize the risks associated with customer products and applications, customers should provide adequate design and operating safeguards.

TI does not warrant or represent that any license, either express or implied, is granted under any TI patent right, copyright, mask work right, or other TI intellectual property right relating to any combination, machine, or process in which TI products or services are used. Information published by TI regarding third-party products or services does not constitute a license from TI to use such products or services or a warranty or endorsement thereof. Use of such information may require a license from a third party under the patents or other intellectual property of the third party, or a license from TI under the patents or other intellectual property of TI.

Reproduction of TI information in TI data books or data sheets is permissible only if reproduction is without alteration and is accompanied by all associated warranties, conditions, limitations, and notices. Reproduction of this information with alteration is an unfair and deceptive business practice. TI is not responsible or liable for such altered documentation. Information of third parties may be subject to additional restrictions.

Resale of TI products or services with statements different from or beyond the parameters stated by TI for that product or service voids all express and any implied warranties for the associated TI product or service and is an unfair and deceptive business practice. TI is not responsible or liable for any such statements.

TI products are not authorized for use in safety-critical applications (such as life support) where a failure of the TI product would reasonably be expected to cause severe personal injury or death, unless officers of the parties have executed an agreement specifically governing such use. Buyers represent that they have all necessary expertise in the safety and regulatory ramifications of their applications, and acknowledge and agree that they are solely responsible for all legal, regulatory and safety-related requirements concerning their products and any use of TI products in such safety-critical applications, notwithstanding any applications-related information or support that may be provided by TI. Further, Buyers must fully indemnify TI and its representatives against any damages arising out of the use of TI products in such safety-critical applications.

TI products are neither designed nor intended for use in military/aerospace applications or environments unless the TI products are specifically designated by TI as military-grade or "enhanced plastic." Only products designated by TI as military-grade meet military specifications. Buyers acknowledge and agree that any such use of TI products which TI has not designated as military-grade is solely at the Buyer's risk, and that they are solely responsible for compliance with all legal and regulatory requirements in connection with such use.

TI products are neither designed nor intended for use in automotive applications or environments unless the specific TI products are designated by TI as compliant with ISO/TS 16949 requirements. Buyers acknowledge and agree that, if they use any non-designated products in automotive applications, TI will not be responsible for any failure to meet such requirements.

Following are URLs where you can obtain information on other Texas Instruments products and application solutions:

### Products

Amplifiers	<a href="http://amplifier.ti.com">amplifier.ti.com</a>
Data Converters	<a href="http://dataconverter.ti.com">dataconverter.ti.com</a>
DSP	<a href="http://dsp.ti.com">dsp.ti.com</a>
Clocks and Timers	<a href="http://www.ti.com/clocks">www.ti.com/clocks</a>
Interface	<a href="http://interface.ti.com">interface.ti.com</a>
Logic	<a href="http://logic.ti.com">logic.ti.com</a>
Power Mgmt	<a href="http://power.ti.com">power.ti.com</a>
Microcontrollers	<a href="http://microcontroller.ti.com">microcontroller.ti.com</a>
RFID	<a href="http://www.ti-rfid.com">www.ti-rfid.com</a>
RF/IF and ZigBee® Solutions	<a href="http://www.ti.com/lprf">www.ti.com/lprf</a>

### Applications

Audio	<a href="http://www.ti.com/audio">www.ti.com/audio</a>
Automotive	<a href="http://www.ti.com/automotive">www.ti.com/automotive</a>
Broadband	<a href="http://www.ti.com/broadband">www.ti.com/broadband</a>
Digital Control	<a href="http://www.ti.com/digitalcontrol">www.ti.com/digitalcontrol</a>
Medical	<a href="http://www.ti.com/medical">www.ti.com/medical</a>
Military	<a href="http://www.ti.com/military">www.ti.com/military</a>
Optical Networking	<a href="http://www.ti.com/opticalnetwork">www.ti.com/opticalnetwork</a>
Security	<a href="http://www.ti.com/security">www.ti.com/security</a>
Telephony	<a href="http://www.ti.com/telephony">www.ti.com/telephony</a>
Video & Imaging	<a href="http://www.ti.com/video">www.ti.com/video</a>
Wireless	<a href="http://www.ti.com/wireless">www.ti.com/wireless</a>

Mailing Address: Texas Instruments, Post Office Box 655303, Dallas, Texas 75265  
Copyright © 2008, Texas Instruments Incorporated